

# PERPETUAL MOTION GENERATOR



MORAY GENERATOR

# Contents

## Chapter IX

**Perpetual Motion Devices Attempting Its Attainment by a Misconception of the Relation of Momentum and Energy 117**

## Chapter X

**The Alleged Inventions of Edward Sommerset, Sixth Earl and Second Marquis of Worcester, and of Jean Ernest Eli- Bessler (Councillor) Orffyreus 125**

## Chapter XI

**Conservation of Energy A Discussion of the Relation of the Doctrine of Conservation of Energy, and the Possibility of Perpetual Motion 151**

## Chapter XII

**Will Perpetual Motion Ever Be Accomplished? 159**

# Chapter I

## DEVICES BY MEANS OF WHEELS AND WEIGHTS Wilars de Honecort

While attempts at Perpetual Motion are as old as the human race, not many of the more ancient devices have been preserved, either by engraving or by explanation.

Among the very earliest of these attempts of which we have detailed information is the device of Wilars de Honecort. He was an architect, and lived in the thirteenth century. The information is preserved in "A Sketch Book" by him which was deposited and remains in the Ecole des Chartes at Paris. About the middle of the nineteenth century comments were published in France on this ancient device. Some of these were translated into English. The following account is an extract from a translation made by Professor Willis, of Cambridge.

*Many a time have skilful workmen tried to contrive a wheel that shall turn of itself: here is a way to make such a one, by means of an uneven number of mallets, or by quicksilver*

Wilars de Honecort presents to us a device for a perpetual motion; it is not clear whether he intends to claim the contrivance of it, or whether he had met with it in the course of his travels. It differs very little from a wellknown contrivance for this purpose which has been so often published, and its fallacy so fully explained in popular books, that it is unnecessary to dwell at length upon the mechanical principles which it involves. It is extremely curious in this place, because it shows the great antiquity of the problem, the solution of which has wasted the time, the brains, and the means of many an unhappy artisan or philosopher.

In the drawing we have now before us, the two upright posts, which are framed together and skilfully braced so as to ensure their steadiness, support between them a long horizontal axle, to the center of which is fixed a wheel with four spokes. The absence of perspective in this drawing makes the wheel appear as if it were parallel to the frame, instead of being, as it is, at right angles to it.

Seven mallets, or arms, each loaded with a heavy weight at the end, are jointed at equal distances to the circumference of the wheel, so that those which happen to have their joints below the diameter of the wheel will hang freely down, but if the wheel be turned round by hand or otherwise, the weights of those which are on the ascending side will, in succession, rest on its circumference, and will, in that position, be carried over the highest part of the wheel and downwards on the descending side, until the arms that bear them are brought into a vertical position and a little beyond it, and then the weight will fall suddenly over and rest on the opposite position on the circumference of the wheel, until its further descent enables it to dangle freely as before. The effect of this mechanism upon the position of the weights is not truly represented, for the upper mallet has fallen over too soon. In the modern form of this contrivance a pin, or stop, is introduced, by which the mallet, when it falls over, is compelled to rest so that its arm shall point to the center of the wheel, and thus the descending weight be held at a greater distance from the center than when ascending. It is extremely probable that this difference is a mere error of the artist, for the drawing has the appearance of having been made from a model of the wheel at rest; a condition in which, of course, it would always be found, unless moved by some external force.

The inventor seems to have  
 action above described  
 place four weights on the  
 and leave but three on the  
 each

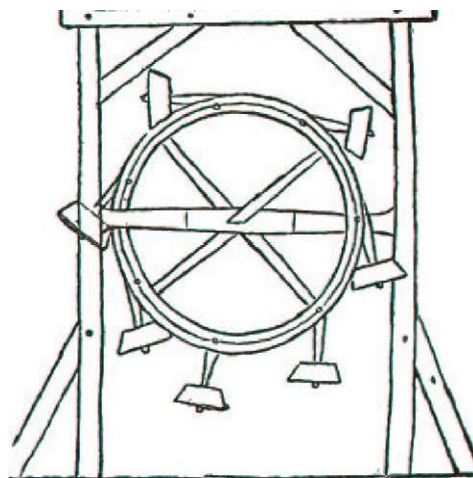

thought that the  
 would always  
 descending side,  
 ascending side,

weight as it rises to the top being intended to leap suddenly over to the descending side, in the manner just explained; or perhaps, as M. Lassel suggests, the contriver imagined that the blows given to the wheel in succession by the falling mallets would help it forward. It is surprising that although the slightest model would show the failure of devices of this class to persons incapable of mathematical reasoning, yet such machines have been seriously proposed in books, and are continually recontrived by ingenious workmen. The allusion to quicksilver in the manuscript shows that Wilars was acquainted with the well-known contrivance described in the books already referred to, in which portions of that metal inclosed in channels are used instead of the falling weights.

### A Repetition of Wilars de Honecort's Plan

This device was brought forth in 1831 in England, and illustrates what we say in the Introductory Essay to the effect of inventors working on the same plan in different parts of the earth and centuries apart.

We are unable to give the inventor's name. He was a correspondent to *Mechanics' Magazine*, and the description as published in *Mechanics' Magazine*, is as follows: A A A is a ring of thin wood; B B B, several spokes, fixed round the ring; C C C, fixed points on the ring; and D D D, heavy weights on the spokes. E E E, heavy weights on the spokes, which will exert no

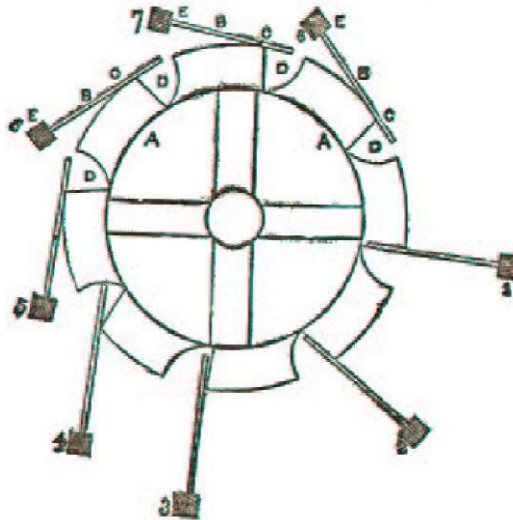

From the position in present, it is evident that righthand side (1 and 2) distance from the center on the other side, will descend until the spoke 1 reaches the position 3, when it will exert no

inventor's name. to *Mechanics'* description as published in as follows:

ring of thin wood; movable round the only allowed to

of the openings D D fixed to the ends of

which the wheel is at the weights on the acting at a greater than those (4 and 5) cause that side to

moving influence, but by which time the weight 8 will have fallen into the position 1, when a similar effect will take place, and so on with the rest.

### Leonardo da Vinci

It is with a mingled feeling of sorrow and exaltation that we note the Perpetual Motion labors of the great Leonardo da Vinci. Of all of the men who ever gave the subject more than a passing notice he is the most famous.

Leonardo da Vinci was an Italian, born in 1452, and died in 1519. He was the illegitimate son of Florentine, lawyer. His mother has been variously described as a peasant, and as of gentle birth. Little about her is known. The father belonged to a family of lawyers, and never repudiated the son, but took him, educated him, and cared for him. It is well for the world that he did, for Leonardo da Vinci has perhaps contributed more to art and learning in the world than any other single individual that ever lived. He was a painter, a sculptor, an architect, a musician, a mechanic, an engineer and natural philosopher. Each subject in art or science that he touched he not only mastered, but improved and embellished. He painted the original of the well-known picture of the Christ and His twelve Apostles, known as the "Last Supper," or the "Last Supper of Our Lord." This, and Mona Lisa, are perhaps the paintings by which he is known to the greatest number of people, and are considered by many connoisseurs the highest perfection in art ever attained by mortal man.

But, as painter and sculptor, he is to be regarded as among the greatest, if not the very greatest that ever lived. In art he ranks beside, if not ahead of Michelangelo and Raffael, and yet they are known only as artists, while he was preeminent in both art and science. The work he did in natural science was entirely original and emanated from an inherent initiative and originality, and as a scientist, he is entitled to rank below only Newton, Gallileo and Copernicus, and very few others. In all the history of the world he is the only man of whom it can be said that he attained the apex of eminence in both art and science.

The information concerning Leonardo da Vinci's devices for obtaining Perpetual Motion is extremely meager. There does not seem to be extant any detailed explanation of just how he expected his different designs to work.

All that is known concerning his efforts is sufficiently illustrated by the following cuts and language from Dircks:

Fig. 1 may be taken as a scheme belonging to the fifteenth century. It seems to be placed at the head as a simple or elementary design for future improvement. It is a chambered drum wheel, containing balls or weights, which, being always farthest from the center on one side, as compared to the other, are expected to keep the wheel constantly rotating.

Fig. 2. Failing in this scheme, the inventor next offers one with weighted levers, which are to fall outwards on one side, but to fall inwards on the opposite side, the weight at the same time sliding up the lever when vertical at the bottom, so as to be nearer the center throughout on the ascending side. But how the weight is to be made to ascend at the bottom remains to be shown.

Fig. 3. The difficulty of elevating the weight would appear to have suggested its immersion in a trough of water, as here shown. The weights seem to be attached to some contrivance to float them *upwards*; but we are perplexed, and so no doubt was da Vinci, how to sink them, or being sunk, how to render them again buoyant by any self-motive process.

Fig. 4. It would appear as though the difficulties observable in Fig. 3 were attempted to be met here, in a plan which evidently combines several views of the case, yet without removing the main

difficulty; for although the weight at the end of the long arm may be quite capable of sinking in the liquid, we still inquire, How is it ever to be raised again?

Fig. 5 seems to be an incomplete sketch, and a mere variation on the preceding designs, with the addition either of machinery below to be worked by it, or to give it motion. Possibly it was proposed to have a magnet at the bottom of the vessel.

Fig. 6 appears to be two designs in one sketch. On one side we have long single levers, with a single weight at their ends, and a weight between each at the periphery; on the other end, double or forked levers and double weights. Its mixed character renders it probable that it was merely some preliminary sketch.

The great value of the present exhibition of these early contrivances of misdirected mechanical ingenuity consists in the convincing evidence which they afford, that all young inventors who occupy themselves in the search for self-motive machines, do little more than reproduce the

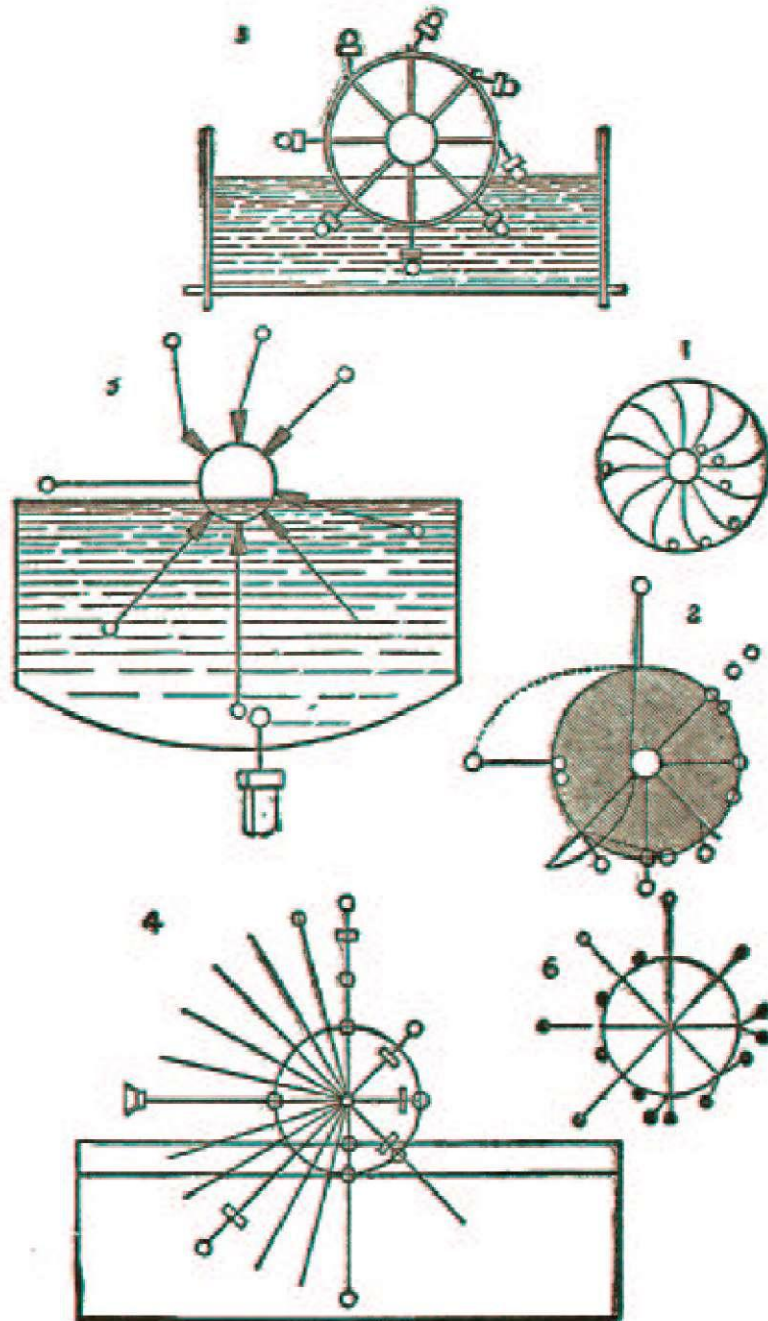

blunders of a past age. After a lapse of five centuries modern inventors often become patentees of contrivances which are only more complicated than the assumed-to-be overweight wheel of Wilars de Honecort, or the six similar ones of Leonardo da Vinci. But such has hitherto been the ignorance of mechanics on this subject, that Fig. 1 of the annexed diagrams has frequently been adduced by writers on the subject, as the veritable wheel invented by the Marquis of Worcester, in the seventeenth century!

### A. Capra's Device

In 1678, A Capra, of Italy, revived the ancient, but still favorite scheme that dates back to the 13th century. (See page 22 ante.) He illustrates his idea with the following

On the wheel A (of the opposite), which must be equipoised between two appended

eighteen in number, all same distance from each exactly of the same counter-weights are small ring by which they

Whilst the are farther from the wheel, they weigh more counter-weights I, low and nearer to the wheel, so that the descend and the weight I

the weight B is alternately descending and the weight I ascending, the wheel will revolve continually. But it must be understood that it is necessary to make the wheel perfectly true in equilibrium, so that it do not weigh more on one side than on the other on account of the counter-weights.

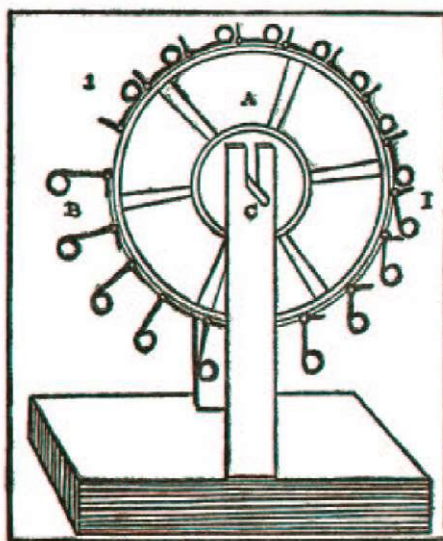

the following fig-  
comment:

facsimile engraving hung well uprights, are counter-weights, precisely at the other, and all weight. The provided with a are hung.

counter-weights B center C of the than the because these are center C of the counterweights B drops; and whilst

**The Device of  
England, 1825**

This inventor was certain he captured the ever-illusive. He gives a description of his machine in the following language:

The annexed drawing shows length taken this enticing jilt tion), though after a long'

hrough pleasant and fields, Through and lonely wilds; quagmires, mosses, muirs and marshes, Where deil or spunkie never scarce is! By chance I happened on her den, And took her when she didna ken.

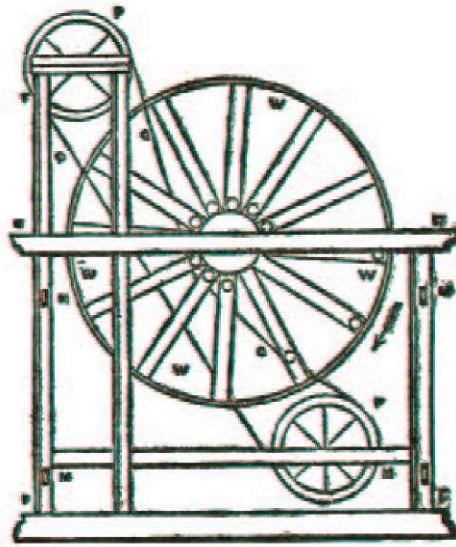

**Dixon Vallance.**

had overtaken and Perpetual Motion. happiness and his effusively joyous

how I have at (perpetual mo- and weary chase—

delightful barren tracts 'Mongst

W W W W represents a wheel with twelve hollow spokes, in each of which there is a rolling weight or ball. C C C C is a chain passing over two pulleys P P. There is an opening round the wheel from the nave to the circumference, so as to allow the chain to pass freely and to meet the weights. The weights are met by the chain as the wheel revolves, and are raised from the circumference till they are at last brought close to the nave, where they remain till, by the revolution of the wheel, they are allowed to roll out to the circumference. By this arrangement the weights are, on one side of the wheel, always at the circumference, so that that side is more powerful than the other, which causes the wheel

continually to revolve. F F F F is the frame of the machine; M M M M the mortices for joining the two sides of the frame by cross rails. The arrows point out the direction in which the wheel turns. I am, yours, &c., Dixon Vallance. Liberton, Lanarkshire, Nov. 10, 1825.

### **Furman's Device**

Strange as it may seem, the patent office of the U. S. government as late as 1884 and 1886, received and filed, seriously considered and granted Letters Patent on Perpetual Motion Devices as appears from the description of Furman's Device following, and from Schirrmeister's "Mechanical Movement" and Enbom & Anderson's "Improvement in Pumps," appearing on pages 38 and 76 respectively, supra.

These were not denominated Perpetual Motion Devices by the inventors, but the specifications show them to be simply that and nothing more.

July 15, 1884, George H. Furman, of Rochester, Ohio, U. S. A., was granted U. S. Patent No. 301979, on

### **"A New and Improved Motor."**

Furman, George H., "A New and Improved Motor," U. S. Patent 36 The essentials are sufficiently shown by the following excerpt from the specifications and the following figure. We have omitted Figure 2, mentioned in the specifications:

#### **UNITED STATES PATENT OFFICE. George H. Furman, of Rochester, Ohio. MOTOR.**

Specification forming part of Letters Patent No. 301979, dated July 15, 1884.

Application filed March 6, 1884. (No model.)

The action of the motor is as follows: A suitable quantity of the small weights  $d$  being placed in the outer drum, F, through the door  $f$ , the machine being at rest, they will accumulate at the lower part of the drum F in the pockets  $c' c'$ . Now, to run the machine a person will apply his hands to the rim H and revolve the outer drum, F, in the direction of the

arrow shown in Fig. 1. This movement of the outer drum will cause the weights *d* to be carried in the pockets *c' c'* to the upper side of the drum, at which point they will roll from the pockets *c' c'* into the pockets *b b* of the inner drum, *G*, where their weight will cause the drum *G* and shaft *E* to revolve. As the pockets *b* of the inner drum pass below the shaft *E* they empty the weights into the troughs *c'* of the outer wheel, *F*, to be again carried above the shaft and dropped into the pockets *b*, so that the inner wheel, *G*, and shaft *E* will be revolved continuously.

### Schirrmeister's Mechanical Movement

July 6, 1886, Charles Schirrmeister, of Brooklyn, Kings County, State of New York, U. S. A., obtained Letters Patent No. 345077, on a new and useful

"Mechanical Movement."

The essentials of the appear from the from the specifications, figures accompanying (Figs. 2, 3 and 4 we

The object of my cheap and simple *mechanical power*; means of a series of right angles to and of motion where power arranged that each arm plane, said arms being with a ball of metal.

sliding or rolling do not show.) weights, which move back and forth as the axis revolves, and the motion is still

10

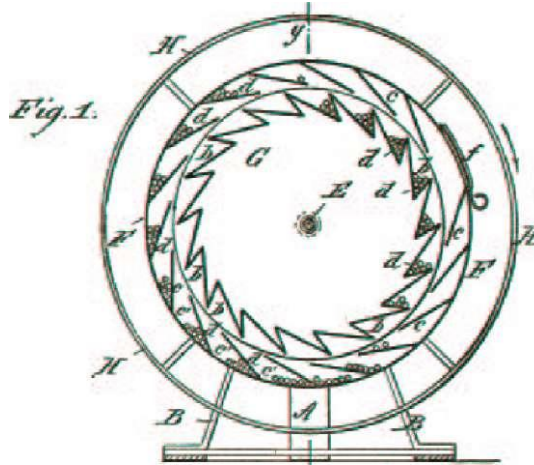

patented device following excerpts and the following the specifications.

invention is to furnish a *means for imparting* and I accomplish this by radial arms placed at projecting from the axis is first applied, and so is in a different vertical weighted at each end

Some of these arms are also made hollow and inclose weights, which move back and forth as the axis revolves, further re-enforced by a series of springs which are attached to the axis by a lever and eccentric.

Taking the simplest form of my device, I illustrate the same by the accompanying drawings, in which —

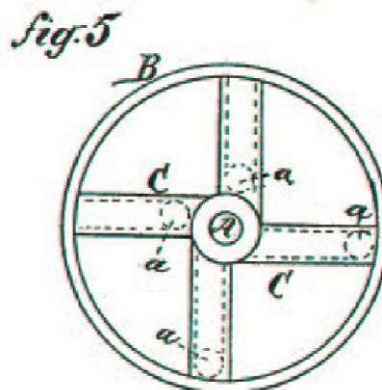
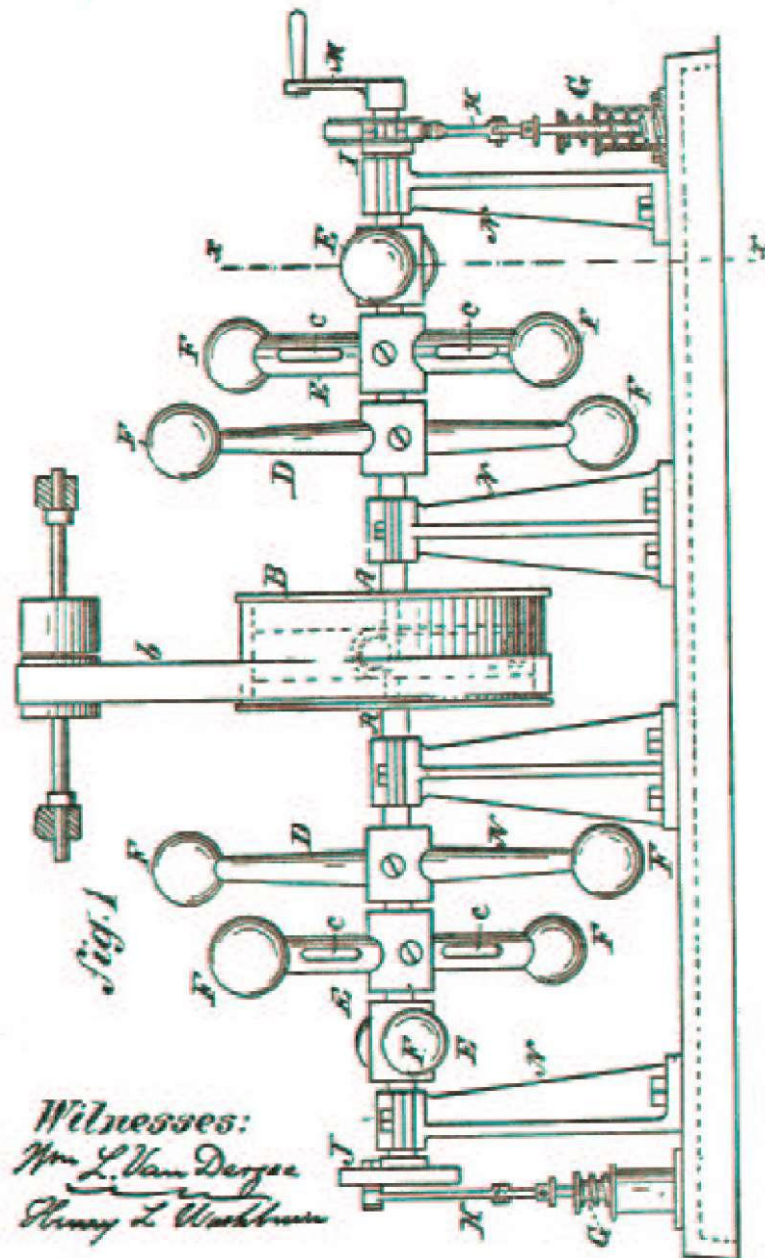

Figure 1 is a side elevation of the entire apparatus. Fig. 2 is a sectional view showing the hollow arm with a rolling weight. Fig. 3 is an end view showing the operation of a reenforcing spiral spring. Fig. 4 is a detailed view showing still further the method of reenforcing motion by springs.

Fig. 5 is a view of the driving-pulley with its hollow arms.



Similar letters refer to similar parts in the several views.

A is the axis to which the power first imparting motion is applied.

N are the bearings supporting the same.

B is the driving-pulley attached to said axis, and from which motion is imparted by means of the driving belt b to any point desired.

C are the hollow arms of the driving-pulley B.

D are the solid arms radiating from the axis A.

E are the hollow arms radiating from the axis A.

F are the solid balls or weights secured to the ends of the arms D and E.

a are the sliding or rolling weights, which are inclosed within the hollow arms C and E.

c are the slots cut into the hollow arms E, to relieve the air-pressure formed by the backward and forward motion of the weights a.

G are springs so arranged as to expend their force upon the axis A by means of the connecting rods H, both attached to the springs and one attached to the axis A by means of the eccentric I and the other to the wheel J at one end of the axis.

K is a balanced lever, upon which the springs G may rest, said lever being supported at each end upon the springs L.

M is a crank attached to one end of the axis A, and serves to show the place and manner in which the power may be applied.

The manner of constructing and operating my invention is as follows: The entire apparatus is made of steel or iron, and the shaft, bearings, arms, springs and connecting-rods are of ordinary form. The main or driving pulley is cast with four hollow arms, in which round weights are inclosed, which move back and forth within the arms when the wheel is set in motion. The solid arms, as well as the hollow arms, which are used in addition to those forming a part of the driving-pulley, are arranged by means of set-screws<sup>2</sup> a suitable distance apart upon the axis and in different perpendicular planes, so as to give steadiness in motion. A thread is cut upon each end of these arms, and the fixed weights are then screwed on. When the shaft or axis revolves, the weights which move toward the ends of the arms above the center accelerate the motion, and the momentum of the machine aids in overcoming the resistance caused by the weights, which are below the center. At the same time the revolution of the eccentric and crank-pin upon the axis depresses the connecting-rods, which in turn depress the springs, which, being released as soon as the eccentric and crank-pin have reached their lowest point, contribute a lifting power to overcome the resistance above mentioned. As shown in the drawings, these springs joined to the connecting-rods may be supported and assisted by other springs.

The power is applied by hand, operating upon a crank at the end of the axis, or may be imparted by steam, hot air, electricity, or in any other known method, and is conducted to any desired point by means of the belt *b*.

Having fully described my invention, what I claim as new, and desire to secure by Letters Patent, is:

I. The combination, in apparatus for increasing mechanical power, of an axis, as A, supported upon bearings N, with a driving-pulley, as B, having hollow arms, as C, with movable weights, as *a*, and radial arms, both solid and hollow, the latter having movable weights, together with fixed weights attached to the end of each arm, all substantially as and for the purpose described.

### **Ferguson's Device**

James Ferguson was an eminent Scotch mechanic and astronomer. He was born in 1710, and died in 1776. He was reared in very humble circumstances, and is known as the Peasant Boy Philosopher. A most interesting story of his life was written by Henry Mayhew, and published in England in 1857, entitled "The Story of the Peasant Boy Philosopher."

He prepared astronomical tables of great value and lectured on astronomical and mechanical subjects. His lectures were edited by a no less eminent man than Sir David Brewster.

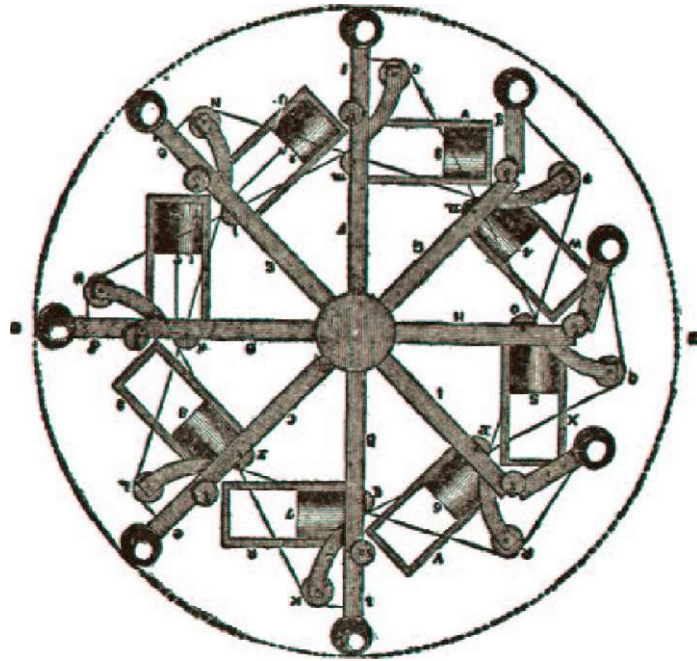

While Perpetual Motion seemed to have received considerable time and attention from him, and while his writings show that he examined a great many mechanical devices, he seems all the time to have entertained serious doubt of the possibility of a machine having self-motive power. However, in 1770, he devised a machine for the purpose of producing Perpetual Motion. It does not appear that he ever offered the machine to the public, or sought publicity for it.

A description of it is to be found in his Common Place Book in the University Library, Edinburg. The description there furnished is as follows:

The axle at A is placed horizontally, and the spokes B, C, D, etc., turn in a vertical position. They are jointed at *s, t, u*, etc., as a common sector is, and to each of them is fixed a frame as R, S, T, etc., in which the weights 7, 8, 9, I, 2, etc., have liberty to move. When any spoke as D is

in a horizontal position, the weight I in it falls down and pulls the part b of the then vertical spoke B straight out, by means of a cord going over the pulleys K and k to the weight I. The spoke C c was pulled straight out before, when it was vertical, by means of the weight 2, belonging to the spoke E e which is in the horizontal position D d; and so of all the others on the right hand. But when these spokes come about to the left hand, their weights 4, 5, 6 fall back, and cease pulling the parts f, g, h, i; so that the spokes then bend at their joints X, y, z, and the balls at their ends come nearer the center A, all on the left side. Now, as the balls or weights at the right hand side are farther from the center A than they are on the left, it might be supposed that this machine would turn round perpetually. I have shown it to many who have declared it would; and yet for all that, whoever makes it, will find it to be only a mere balance. I leave them to find out the reason.

### B. Belidor's Device

This device was incubated in the <sup>14</sup>brain of an American. His name is unknown. We have denominated it "B. Belidor's Device," not because B. Belidor was the inventor, but because the account of the invention was furnished by him. This device seems to the author to have possessed originality, though, of course, it failed to work for reasons clearly apparent.

An account of it was given in the Journal of Franklin's Institute, Philadelphia, in 1828.

The article contributed by B. Belidor is as follows:

Even the pursuit after perpetual motion, hopeless as it is, may not be considered entirely vain, in occasionally leading to useful modifications of machinery. As an instance of this, I here submit to you a plan suggested by an ingenious friend of mine, several years ago, as in the diagrams annexed, Fig. 1, a perpendicular, and Fig. 2 a horizontal view.

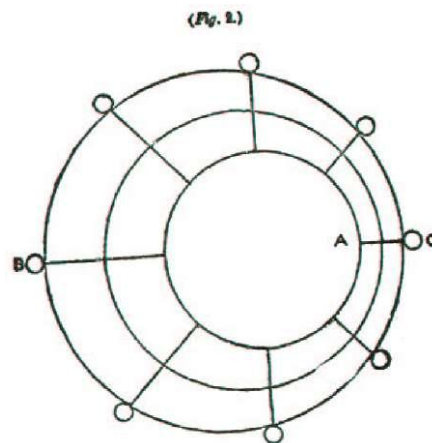

A A, two vertical wheels, placed diagonally, and revolving on the axes X X. The levers B B and C C are hinged at the peripheries of the wheels. By rotation the arms B B are projected from the center of motion, while the arms C C are drawn in.

It is plain that a series of arms as shown in Fig. 2, will produce an eccentric motion, causing the weights at their ends apparently to preponderate on the side B. BELIDOR.

### Desagulier's Proposition on the Balance

This so-called problem is of doubtful classification. The author of the problem did not claim that the discovery of the problem discloses any means for attaining Perpetual Motion, and, yet, it is apparent that if the author of the problem was correct in his solution of it, Perpetual Motion was thereby already within his grasp. The difficulty about it all is that while the problem is quite interesting, the author's solution shows that he was not familiar with even fundamental mechanics. The name of the author was J. T. Desagulier, LL.D., F. R. S. He was a minister of the gospel, but evidently gave considerable attention to mechanical questions. He is mentioned in chapter X of this work.

Rev. Desagulier presented two problems of the balance. One he calls "A Proposition on the Balance, not taken notice of by Mechanical Writers, explained and confirmed by an Experiment" The article under this heading is as follows:

In the last papers I published in "Philosophical Transaction" against this perpetual motion, described in No. 177, I intreated the author to permit me to say nothing as to what alterations he might make in his engine, resolving to leave it to others to show him that upon that principle all he can do signifies nothing. But I find since, in the "Nouvelles de la Republique" for December last, that he still persists to urge some new contrivances, which being added, he conceives his engine must succeed. To this I answer, that I undertook only to shew that his first device would faile, which yet I should scarce have done if I had thought a dispute of this nature could have lasted so long. To come, therefore, to the point where he saith that this engine may well succeed without alteration, because he hath tryed with liquors put into bellows immersed in water; I again say that I grant him the truth of the experiments, but deny the consequences he would draw from them. I have already given the reasons of my dissent, which this gentleman is not pleased to understand.  
But

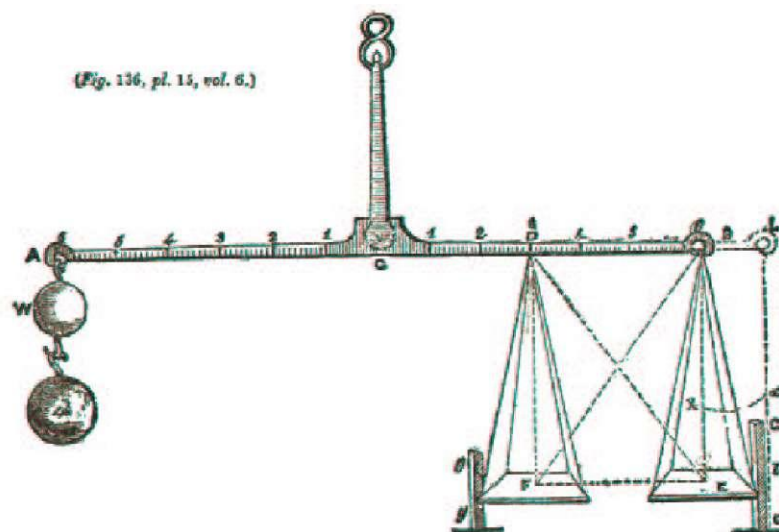

to end all controversies, he may please to consult Mr. Perrault, De la Hire, or any other at Paris well known to be skilled in hydraulicks, and I doubt not but he will find them of the same opinion with Mr. Boyle, Mr. Hook, and other knowing persons here, who all agree that our author is in this matter under a mistake.

**A Proposition on the Balance, not taken notice of by Mechanical Writers, explained and confirmed by an Experiment.**

A B is a balance, on which is supposed to hang at one end, B, the scale E, with a man in it, who is counterpoised by the weight W hanging at A, the other end of the balance. I say, that if such a man, with a cane or any rigid straight body, pushes upwards against the beam anywhere between the points C and B (provided he does not push directly against B), he will thereby make himself heavier, or overpoise the weight W, though the stop G G hinders the scale E from being thrust outwards from C towards G G. I say likewise, that if the scale and man should hang from D, the man, by pushing upwards against B, or anywhere between B and D (provided he does not push directly against D), will make himself lighter, or be overpoised by the weight W, which before did only counterpoise the weight of his body and the scale.

If the common center of gravity of the scale E, and the man supposed to stand in it, be at  $k$ , and the man, by thrusting against any part of the

beam, cause the scale to move outwards so as to carry the said common center of gravity to  $k x$ , then, instead of B E, L  $l$  will become the line of direction of the compound weight, whose action will be increased in the ratio of L C to B C. This is what has been explained by several writers of mechanics; but no one, that I know of, has considered the case when the scale is kept from flying out, as here by the post G G, which keeps it in its place, as if the strings of the scale were become inflexible. Now, to explain this case, let us suppose the length B D of half of the brachium B C to be equal to 3 feet, the line B E to 4 feet, the line E D of 5 feet to be the direction in which the man pushes, D F and F E to be respectively equal and parallel to B E and B D, and the whole or absolute force with which the man pushes equal to (or able to rise) 10 stone. Let the oblique force E D (= 10 stone) be resolved into the two E F and E B (or its equal F D) whose directions are at right angles to each other, and whose respective quantities (or intensities) are as 6 and 8, because E F and B E are in that proportion to each other and to E D. Now, since E F is parallel to B D C A, the beam, it does no way affect the beam to move it upwards; and therefore there is only the force represented by F D, or 8 stone, to push the beam upwards at D. For the same reason, and because action and reaction are equal, the scale will be pushed down at E with the force of 8 stone also. Now, since the force at E pulls the beam perpendicularly downwards from the point B, distant from C the whole length of the brachium B C, its action downwards will not be diminished, but may be expressed by  $8 \times BC$ ; whereas the action upwards against D will be half lost, by reason of the diminished distance from the center, and BC is only to be expressed by  $8 \times \wedge f$ ; and when the action upwards to raise the beam is subtracted from the action downwards to depress it, there will still remain 4 stone to push down BC the scale; because  $8 \times BC - 8 \times \wedge f = 4BC$ .

Consequently, a weight of 4 stone must be added at the end A to restore the equilibrium. Therefore a man, &c., pushing upwards under the beam between B and D, becomes heavier. Q. E. D.

On the contrary, if the scale should hang at F, from the point D, only 3 feet from the center of motion C, and a post G G hinders the scale from being pushed inwards towards C, then, if a man in this scale F pushes obliquely against B with the oblique force above mentioned, the whole force, for the reasons before given (in resolving the oblique force into two others acting in lines

perpendicular to each other) will be reduced to 8 stone, which pushes the beam directly upwards at B, while the same



are a great many cases wherein the velocities are neither proportionable to the distances from the center of motion of a machine, nor to the arcs described by the weights or their points of suspension. Therefore, it is not a general rule that weights act in proportion to their distances from the center of motion; but a corollary of the general rule that weights act in proportion to their velocities, which is only true in some cases. Therefore, we must not take this case as a principle, which most workmen do, and all those people who make attempts to find the perpetual motion, as I have more amply shewn in the Phil. Trans., No. 369.

But to make this evident even in the balance, we need only take notice of the following experiment: A C B E K D is a balance in the form of a parallelogram passing through a slit in the upright piece N O standing on the pedestal M, so as to be moveable upon the center pins C and K. To the upright pieces A D and B E of this balance are fixed at right angles the horizontal pieces F G and H I. That the equal weights P W must keep each other in sequilibrio, is evident; but it does not at first appear so plainly, that if W be removed to V, being suspended at 6, yet it shall still keep P in sequilibrio, though the experiment shews it. Nay, if W be successively moved to any of the points i, 2, 3, E, 4, 5, or 6, the equilibrium will be continued; or if, W hanging at any of those points, P be successively moved to D, or any of the points of suspension on the cross-piece F G, P will at any of those places make an sequilibrium with W. Now, when the weights are at P and V, if the least weight that is capable to overcome the friction at the points of suspension C and K be added to V, as u, the weight V will overpower, and that as much at V as if it was at W.

From what we have said above, the reason of this experiment will be very plain.

As the lines A C and K D, C B and K E, always continue of the same length in any position of the machine, the pieces A D and B E will always continue parallel to one another, and perpendicular to the horizon. However, the whole machine turns upon the points C and K, as appears by bringing the balance to any other position, as a b e d; and therefore, as the weights applied to any part of the pieces F G and H I can only bring down the pieces A D and B E perpendicularly, in the same manner as if they were applied to the hooks D and E, or to X and Y, the centers of gravity of A D and B E, the force of the weights (if their quantity of matter is equal) will be equal, because their velocities will be their perpendicular ascent or descent, which will always be as the equal lines 4 / and 4 L, whatever part of the pieces F G and H I the weights are applied to. But if to the weight at V be added the little weight u, those two weights will overpower, because in this case the momentum is made up of the sum of V and u multiplied by the common velocity 4 L.

Hence follows, that it is not the distance C 6 multiplied into the weight V which makes its momentum, but its perpendicular velocity L 4 multiplied into its mass. Q. E. D.

This is still further evident by taking out the pin at K; for then the weight P will overbalance the other weight at V, because then their perpendicular ascent and descent will not be equal.

The Rev. Dr. Desagulier was evidently a man of scientific turn and capacity. It is unusual to find ministers deeply interested in scientific matters, and yet, he seems to have been. The net result of his experiments can be succinctly stated as follows:

In the first problem there is *no change in the distance of the center of gravity from the support*, and, therefore, there could be no disturbance of the equilibrium.

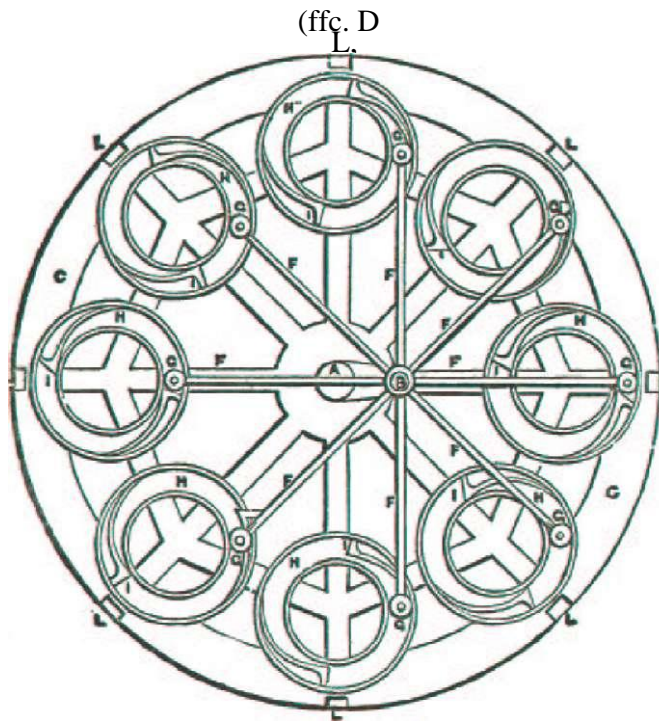

In the second problem there *is a change in the distance in the center of gravity from the support*, and there must have been a disturbance of the equilibrium.

### **John Haywood's Device**

In 1790, John Haywood, of Long Acre, Middlesex, draftsman and mechanic, obtained British patent on:

"A machine for working mills and engines without the aid of fire, water, or wind, or in aid of all or any of those or any other powers."

The specification describes the device as follows:

"The machine acts on a rotative principle, or, in other words, has a revolving circular or circulating motion round an axis, center, or centers. It may be made or constructed of any materials or matter whatsoever, so it be of sufficient strength to sustain the power of 'action when applied to any mill, engine, or machine to which action or motion can or may be communicated by a wheel. The size or dimensions of this machine are by no means confined, but may be varied or altered as circumstances may require.

"References to the drawings of the machine hereunto annexed: Fig. 1 is the section of the machine. A, A, B, a cranked or double center, fixed to the stand or frame D by the bolts E. C, C, the wheel which turns or revolves round that part of the cranked center mark A. F, levers which turn or revolve round the cranked center B. G, G, rollers or weights which revolve in the circular guides or grooves by means of the leavers F. H, H, circular grooves or guides which are affixed to the inner sides of the wheel. N.B. the distance from A to B is the radius in all cases to determine the space between the center of the guide or groove H and the center of the roller or weight G. The distance of the two concentric circles which form the guides or grooves H must be equal to the diameter of the roller or weight G. I, I, springs which stop the rollers or weights G from returning when at the horizontal diameter of the wheel. K, weights, which may be increased or diminished at pleasure. L, ledges which connect the sides of the wheel together. N. B. By fixing cogs or teeth on the rim of the wheel, so as to connect it with any mill, machine, or engine to which motion can be given by a wheel, the power of this machine may be communicated."

### **Explanation of the Failure of the Preceding Wheels and Weights Devices**

It must not be presumed that the preceding devices shown in this chapter constitute any considerable part of the Wheels and Weights Devices that have been constructed through the hope of attaining Perpetual Motion. Of all the means whereby Perpetual Motion has been sought wheels and weights have been by far the most prolific. There is scarcely a village or a rural community in the civilized world that cannot point out its Perpetual Motion worker, and he generally starts with wheels and weights, though often, after long labor and final failure with wheels and weights, he still exploits other attractive fields of hopeless endeavor. Of the devices of that kind, accounts of which have appeared in scientific journals, or application for patents upon which have been made, and, indeed, patents often granted, it would be possible to write a book of thousands of pages, but to do so would be to no purpose.

It is believed by the author that the preceding devices are sufficient to illustrate, and show the controlling features of all the various mechanical contrivances for the utilization of wheels and weights as a means of Self-Motive Power. Countless others could be shown of more or less

complicated mechanism, but an examination would disclose the fact that each gets back to some combination of parts well illustrated in the preceding. Also, in endeavoring to express why all wheels and weights devices have failed to work, each essential point of weakness is disclosed in the preceding. Now, why have they failed to work, and wherein are they inherently wrong and unscientific?

A cursory examination of the preceding devices shows that each depends ultimately on the supposition:

1. That a descending weight elevates an equal weight through a distance equal to the descent, and at the same time overcomes the frictional resistance of mechanism, both ascent and descent being measured on perpendicular lines, or
2. That weights affixed to an axis and caused to have a longer leverage on the descending side than on the ascending side, and consequently the downward pull on the long lever side is supposed to be greater than the downward pull or resistance on the short lever side of the axis.

If the fallacy of these supposed principles is explained and fully understood, it disposes, and disposes effectually, of the possibility of obtaining Perpetual Motion by means of wheels, weights and the force of gravity.

It should be remembered that a wheel is a lever, or rather it is a continuous series of levers nothing more nothing less.

We first refer to the figure shown in A. Capra's device, page 33 ante. The left side of this wheel is, of course, supposed to be the descending side on which the weights are farthest from the center of the wheel. It is apparent that are having any leverage whatever, while a much being made to ascend. The few of the weights have by leverage

only five weights  
advantage  
greater number are  
advantage which a  
virtue of the

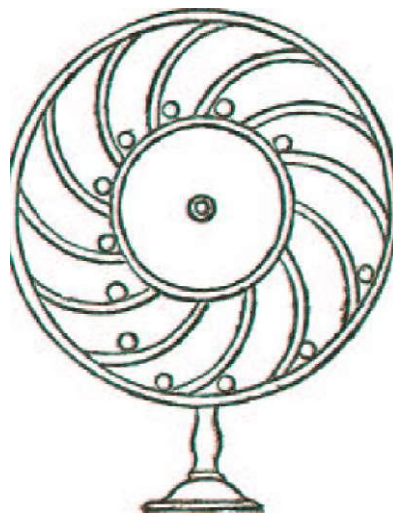

pulling downward is always exactly counterbalanced by an *increased number* of weights being drawn upward. It should be borne in mind that the direction of the force of gravity is toward the center of the earth, and not in the direction of the motion of the wheel, except at the extreme left side of the wheel.

Again, consider the figure appearing on page 63. It is manifest that the weights on the right hand are further out, and have a leverage advantage of the weights on the left hand side, but it is also manifest that there is, and always must be, a greater *number* of weights on the left hand side. The *greater leverage* of the weights on one side is exactly balanced by the greater number of weights on the other side.

For a further illustration, take the figure shown on sheet 65, ante. The weight "1" has a distinct advantage over weight "5." Weight "2" has a distinct advantage over weight "6." But here we have only three weights: 1, 2 and 8, tending to pull the wheel from left to right, whereas there are five weights, 3, 4, 5, 6 and 7, tending to prevent its going to the right.

In other words, if weights 1, 2 and 8 were removed, it is clear that the wheel would turn back to the left by reason of the action of the weights 3, 4, 5, 6 and 7. Here again the *leverage advantage* which weights have descending is counterbalanced by the *increased number of weights* on the opposite side acted on by the force of gravity, tending to prevent the descent of those having the greater leverage.

All the simpler devices failed, of course, to work. The more complicated devices are simply efforts to overcome the elementary principles that prevented the simpler devices from working. Among these that of Dixon Vallance (see page 34, ante), is best adapted to illustrate the folly and the fallacy of these various devices to overcome elementary principles.

We here refer to the figure appearing on page 35, ante, shown in connection with Dixon Vallance's Device. The obvious purpose was to keep all the weights close to the hub, except those depended upon to produce continuous motion by their greater leverage.

To the untrained and untechnical person it would perhaps not be manifest at first just why the Vallance machine failed to work. Here is its failure: Weight "c" must be raised toward the hub of the wheel. To raise that weight requires the application of force. That force must be supplied. The belt "cc" would work more freely if it were not elevating a weight, and the force required from "w" to turn the wheel so as to el-

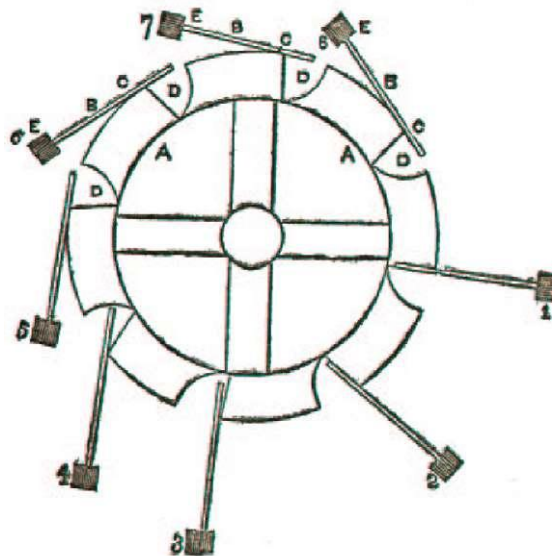

evate the weight at "c" is counterbalanced by the resistance the weight "c" offers to being raised, and consequently to the motion of the belt and in turn to the progress of the wheel.

It should always be remembered that, omitting friction, the energy exerted by a descending body is the *perpendicular distance* of its descent multiplied by its weight. For, notwithstanding what its course may be from an elevated point to a lower point the energy accumulated in the descent is still the product of the perpendicular distance and the mass, or weight.

In all of these devices it is apparent that every weight is brought back by some force from the lowest point it reaches to the same elevation from which it started to descend. It is axiomatic, therefore, that the perpendicular ascent is equal to the perpendicular descent. The ascending weight and the descending weight are, of course, the same. Therefore, the product of the weight and the perpendicular distance of ascent is exactly equal to the product of the weight and the perpendicular distance of *descent*. Hence, there is an exact balancing of energies, and no motion results. Any motion imparted by wind, water or steam will, if the moving force be withdrawn, soon be overcome by unavoidable friction, and a state of rest follows. There can be no doubt that any attempt to attain Self-Motive Power by means of wheels, weights, levers, and the force of gravity must result in failure. The thing itself is physically impossible.

In addition to what is above stated, read carefully Chapter XI, on Conservation of Energy ; also read Chapter XIV, entitled "The Seeming Probability of Effecting a Continual Motion by Solid Weights in a Hollow Wheel or Sphere" at page 290 of this book.

# Chapter II

## DEVICES BY MEANS OF ROLLING WEIGHTS AND INCLINED PLANES

### Device by Mercury in Inclined Glass Tube and Heavy Ball on Inclined Plane

Neither the inventor's name nor his nativity can we give. An account of the invention was furnished by a correspondent to Mechanics' Magazine in 1829. The account is as follows:

To the curious who delight in mechanical intricacies, to whom ingenuity of contrivance is the goal for which they run, nothing seems to afford and require such endless resources as that most puzzling thing perpetual motion. The unfortunate name "perpetual motion," if changed for "mechanical experiment," would eventually, perhaps, remove the real cause of censuring it, by the different idea of the object aimed at.

I now beg leave to offer some account of a combination of movements, which, from its originality, and seeming to possess every requisite for retaining it in action, may possibly be acceptable.

This diagram shows a side view. are raised two supports B, each having a center of the

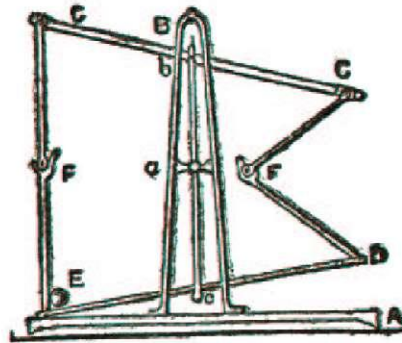

On the stand A hole at a, to receive the axle

balanced apparatus, consisting of C, a glass tube containing a portion of mercury G; and D, a grooved scaleboard, in which a ball, E, can roll backwards and forwards. F F are two jointed levers, which are to serve, when struck by the ball, to reverse the position of the compound balance: the whole centred at a, the tube at b, and the grooved board at c. In its present position, the mercury (it is supposed), having flowed to the end C, will depress D, and cause the ball E to roll to D, and depress the end G F D; and so on continually.

### Series of Inclined Planes

This scheme is of English origin, and was promulgated in 1864. The name of the inventor is unknown, but he described his invention in a communication to a scientific publication in the following language:

The accompanying diagram represents a series of inclined semi-tubes connected together in the form of a rectangle.

The ball A, is placed at the top such a position that it shall which point it will have sufficient gravity to carry it up the ascent supposing the inclines and endless, the repetition of the also endless. I think it is not suppose that a perpetual ball will take place, from the velocity imparted to it by its sufficient to carry it from A to *being at the same level*. I think

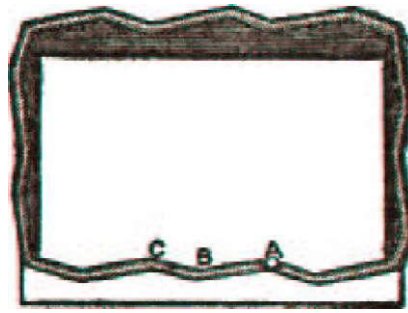

of an incline in descend to B, at ficient velocity or to C; and so ascents to be movement must be unreasonable to movement of the fact that the *first* descent is C, *those two points* the only thing to

guard against is the ball rushing over the point C, and thus accelerating the velocity at each descent. The incline on road upon which the ball runs can be made either circular, square, octagonal, or, in fact, almost of any form.

**Device by Oscillating Trough and Cannon Balls**  
(Name of inventor unknown)

An adaptation from a "Perpetual Pump" substituting cannon-balls for water. An account of this invention was published in London in 1825, in the language of the inventor, who says:

The description of the perpetual pump has suggested to me whether the long-sought "perpetual motion" may not be found by a simple mechanical alteration of that machine, and substituting a cannon-ball as a *pri-mum* mobile, in lieu of the Water, not always obtainable. I would recommend that in the bottom of the trough be inserted at each end two dropping-boards, of a triangular form, moving on an axis at one corner, one of which falling below the level of the trough at the elevated end, the other shall be raised by the stop affixed to the standard-post, which, throwing the ball again back to the former end, shall depress that, until the same process is repeated in perpetual activity.

DESCRIPTION—Fig. 1. A, the trough, swinging on an axis at B. C, the cannon-ball, raised by one of the dropping-boards, D, whilst the other falls through the opening at E, into the trough. F, the support or stop, raising the dropping-board D. The center of the trough ought to be pierced, leaving the sides as a support to the ball, which ought not to be wider than the ball may travel freely through.

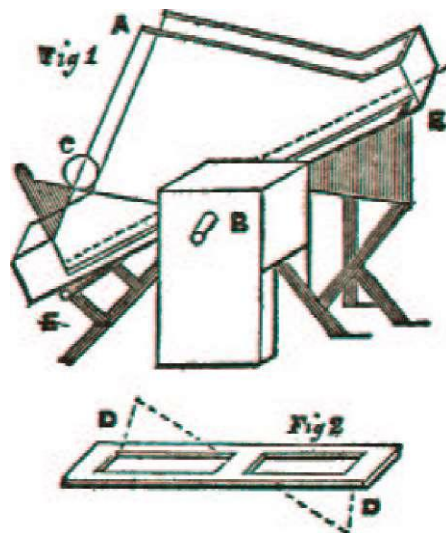

Fig. 2. D D, the dropping-boards, which pass through the center so as to leave a sufficiency of the trough as a resting place for the ball to give a momentum, and depress the trough, previously to its being again raised by the dropping-board.

We meekly venture to call the attention of this inventor, if he is still living, and to any others who may be working along the same line, that to our certain knowledge water is more generally obtainable than cannon-balls. We, therefore, suggest the use of water instead of cannon-balls.

**Unpublished Incline Plane and Weights Devices Noted by the Author**

Except the preceding three devices the author does not remember ever to have seen reported in any book, patent, application for patent, or report, the account of a device for obtaining self-motive power by means of weights and inclined planes, and yet, it is believed by the author from the use that has been made of inclined planes and rolling weights in demonstrating mechanical principles by many natural philosophers, and also from devices that have from time to time been brought to the attention of the author during thirty years last past, that the inclined plane with rolling weights has been a fertile field of folly among Perpetual Motion seekers.

On a number of occasions the author has been asked to view and inspect mechanical devices of that kind, which it was claimed by the confident inventor and his friends "would surely work when just one little thing could be overcome" The phraseology was sometimes varied a little from the preceding quotation, but the substance was always there.

In one instance the device attracted the enthusiastic attention and elicited breathless interest from a doctor and surgeon of much more than ordinary skill and intelligence in his profession, and was hopefully regarded by a number of other persons who had had schooling advantages and were supposed to be versed in the rudiments of mechanics, and, it would seem to the author, ought at first sight to have perceived the fallacy and hopelessness of the inventor's dreams.

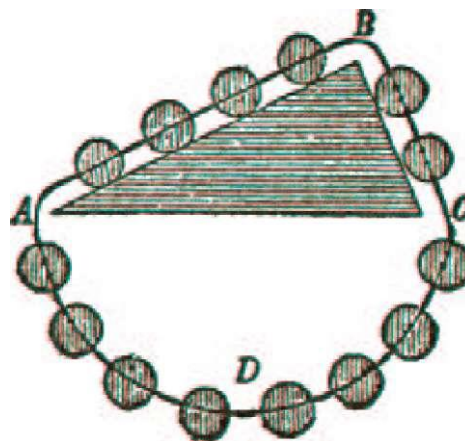

All of these claimed inventions relying on the inclined plane with rolling weights were so nearly alike in the principle involved that all may be illustrated by the following explanation:

The above figure shows a vertical section of a device that illustrates the controlling principle in all of these devices. It is manifest that the balls between A and C are hanging equally between A D and C D, the points of suspension A and C being in a horizontal line. It is also manifest that there will be a greater number of balls on the sloping incline A B than on the sloping incline B C. The Perpetual Motion seeker has always argued to himself that the *four* balls between A and B should pull stronger to the left at B than the two balls between B and C can pull. Sometimes this device has been varied whereby the balls would roll freely down the incline from B to A and then roll back toward C down another incline where they would be supposed to strike a lever and impel a ball from C to B, which ball would then roll down the incline B A, and so on indefinitely.

The error of all this lies in the fact that the four balls between B and A will not elevate the two balls between B and C for the reason that they are on a less inclined slope. As we would ordinarily state it, B C is a "steeper" incline. One ball between B and C by force of gravity pulls stronger toward C than one ball on B A will pull toward A. It is manifest, therefore, that an equilibrium requires a greater number of balls on B A than B C.

B A is longer and accommodates a greater number of balls than can be accommodated on B C. The number of balls that can be accommodated on the respective sides is always found to be such that the small number of balls between B C pull in the aggregate toward C the same as the greater number of balls between B and A pull toward A, and thus equilibrium is established.

It is manifest, therefore, that with the pull from B toward C equal to the pull from B toward A, the mechanism finds its balance and motion ceases. This is true of all similar devices.

# Chapter III

## HYDRAULIC AND HYDRO-MECHANICAL DEVICES Enbom & Anderson's Pump

June 13, 182 U. S. Patent, No. 259514 was granted to Andro Enbom and John A. Anderson, of Augusta, Kansas, U. S. A., on

"Improvements in Pumps."

It seems probable that the inventors did not suspect, and that the patent office examiners did not discover that the device had in the claimed "Improvement" the essentials of self-motive power. An examination of the specifications clearly shows, however, that the claim of the inventors that "the water lifted by the pump is caused in its passage over the wheel  $A^2$  to give power to the same and thus lessen the labor required" presupposes the principle of self-motive power. The following figure taken from the specifications and the following excerpt from the specifications illustrate the intended operation:

The operation is substantially as follows: By the application of power to the crank a revolution is given to the main shaft A, and by means of this the pump-handle is properly actuated through the intermediate mechanism described. The water lifted by the pump is discharged through the spout  $e$  to the buckets of the wheel  $a^2$ , and by these is delivered to the trough F. By means of the construction described the water lifted by the pump is caused, in its passage over the wheel  $e'$ , to give power to the same, and thus lessen the labor required to produce a given result.

We suggest to the inventors that if instead of elevating the water to the place of discharge E' they discharge it at the level of the trough "F" they

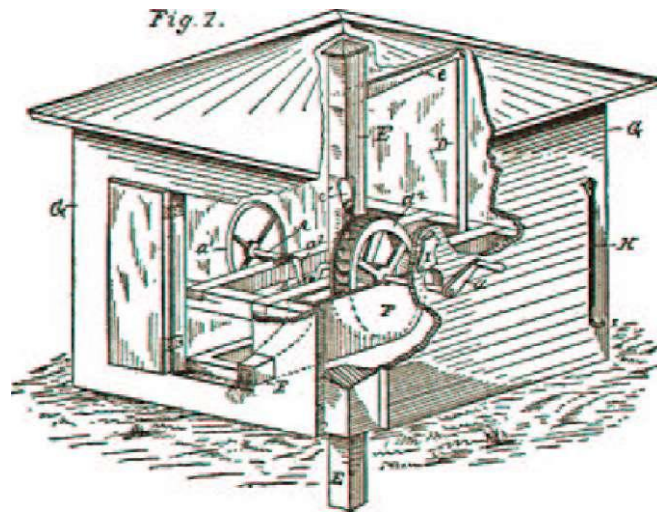

will lessen the distance of elevation and will save many times the energy that can be realized by the descent of the water from the level of E' to the level of "F."

### Device of "Ed. Vocis Rationis"

In 1831 Mechanics' Magazine printed an article tributed by a correspondent who signed Vocis Rationis." He claimed to have invented a very powerful Perpetual Motion Machine.

His enthusiasm is as interesting as his device give the article as published in full:

I propose to endeavor to show how my plan motion could be applied to practical and purposes. With a view to this, I give the with the following description of its and use: Let A represent the side-wall or

article con- himself "Ed. invented a very

is absurd. We

of perpetual useful prefixed sketch, construction

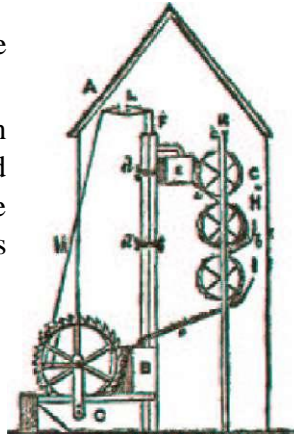

gable-end of a house, from 40 to 50 feet in elevation; B, a cistern, filled with water, having an orifice near its bottom, and another open at the top, for the ready escape of waste water, as before; C, a reservoir, so far filled with water as not to come in contact with the bottom of the water-wheel D, which, being an undershot wheel, may, of course, be of such radius as is suitable for the power required to raise the water. Let E be another cistern, filled with water, equal to and provided with orifices as in cistern B, both orifices together discharging water faster than it escapes from the lower orifice of the cistern B; F, two (or more, as the case may require) pumps, or expressing-fountains, supported against the walls by ties *dd*, and having their cylinders inserted in the reservoir C, and their lower suckers fixed at a little less than 32 feet above the surface of the fluid in the reservoir C. These expressing-fountains discharging their water into the cistern E a trifle faster than it escapes from its lower orifice, at an elevation of at least 33 or 34 feet above the surface of the water in the reservoir C, will afford space for water-wheels, supported against the wall by the upright K, say three water-wheels, G H I, of at least eight feet in diameter each, or two only of greater diameter. The upper wheel G being an undershot one, if not of greater radius than four feet, which it might be, may have its axle fixed at an altitude of at least 30 feet, and allowing the space of a foot between each water-wheel for the troughs *a* and *b*, which collect and convey the water from wheel to wheel, will give a space of 22 feet, occupied by the three water-wheels, leaving 10 feet for the descent of the water by the trough *c* to the cistern B (which may be four or five feet in depth), and thence to the reservoir C, which may be three or four feet in depth; also the cistern E may be four or five feet in depth, and all of other corresponding dimensions *ad libitum*. To produce the motion, remove the plugs or stoppers from the lower orifices of the cisterns E and B; the water rushing from the latter turns the great water-wheel D, which works the expressing-fountains into the upper cistern E; from the orifices of which, the water escaping turns the undershot wheel G (which may be of larger diameter, if required); whence being collected by the spout *a*, it shoots over and turns the wheel H; being collected by the spout *b*, it turns the overshot wheel I; whence being collected by the spout *c*, it is conveyed into the cistern B, from thence to the waterwheel D, and, finally, into the reservoir C, from which it is raised again by the fountains into the upper cistern E; and so on as long as you please, or as long as the whole keeps in repair and in good order. The apparatus may, with facility, be stopped for convenience at any time without fear of derangement, because the fountains carrying water faster than it escapes from the lower orifices, the cisterns will be always full; and it may be again set in motion with equal facility. With the above proviso, it cannot stop till the prevailing natural causes which gave it motion—viz., the pressure of the atmosphere and the descent of water, which in their nature and tendency are of themselves perpetual— shall be diverted. Thus you may have the power, free and disposable, of three water-wheels in perpetual motion, to be applied to such useful purposes of machinery within the building as its inmates may require. A supply of water-mills might be thus provided in any situation—in the center of the metropolis or other large towns—in places subject to a deficiency of rivulets suitable for mills on the common system. Neither would there be any necessity for resorting to rivers, or raising immense buildings upon their banks; wherever there was a convenient house, it might be readily appropriated with little further expense than machinery.

Yours, etc.,

ED. "Vocis RATIONIS." Jan. 10, 1831.

### Bockler's Plates

In 1662 George Andrew Bockler published a work on mechanics. The work is replete with fine drawings. Not a great deal of space is devoted to Perpetual Motion devices, but the following three plates which are numbered ISO, 151 and 152 in his work are shown as Perpetual Motion devices.

These devices do not appear to have been the inventions of Bockler himself, but are devices noticed by him. They are not explained with any considerable detail

Figure 150 is "A Water Screw," and it is stated that the inventor intends it for a Perpetual Motion device, and it is further stated that he has scarcely worked out his purpose. The author states that the excellence consists in the proportion and distribution of the wheel, balls and weights, and says further that he does not describe it in detail, and that it is his intention to publish at a future time a separate treatise on Perpetual Motion in which this and other similar machines will be considered. He gives the first as Fig. 150, "A Water-screw" the purpose of which is not quite so obvious as to be understood at the first view of the figure;

Fig. 150

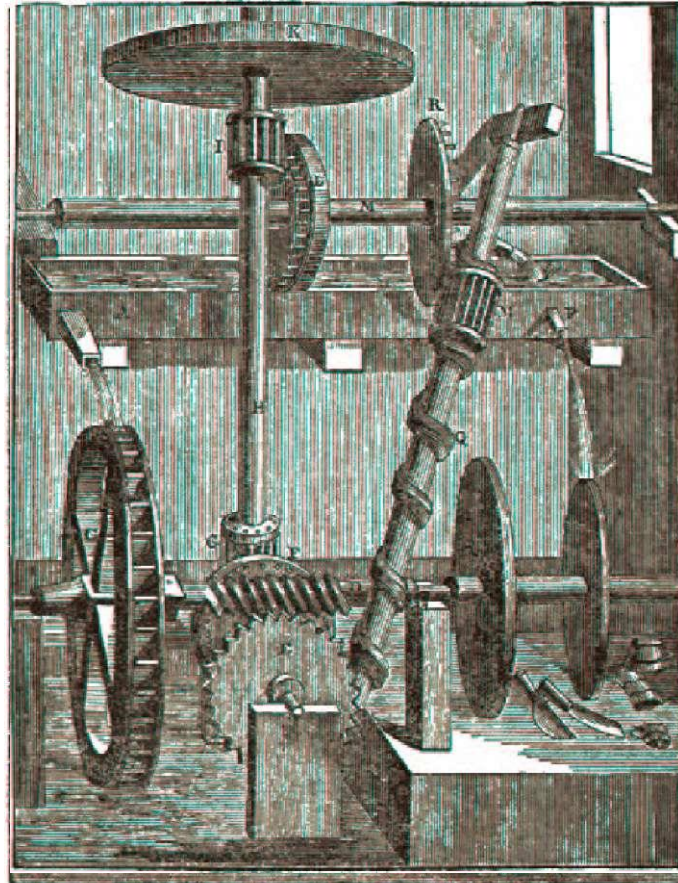

for the inventor intimates that he intends it for a perpetuum mobile. He has, however, scarcely worked out his purpose, as we may, nevertheless, say without any prejudice to the inventor. Nor will we here describe how the excellence of this work consists in the proportion and distribution of the wheel, and the balls or weights, because it is our intention to publish, at a future time, a separate treatise on the perpetuum mobile, in which we shall consider this and several similar machines.

Figure 151 is "A Water Screw," having a grindstone for cutlery. The author remarks concerning this machine as follows:

This machine also is intended for a perpetuum mobile. The inventor discharges water from the reservoir A, by the canal B, on the water-wheel C, which turns the open screw-cylinder D, by means of the toothed wheel E, the cogwheel F, the spoked wheel G, together with the cylinder H, and the spoked wheel I, whilst this spoked wheel I, catching the small cog-wheel L, together with the cylinder M, and the handle R, turns the small spoked wheel of the screw-cylinder H, and the

screw-cylinder itself, and thus draws up again the water discharged from the reservoir A through the spiral screw Q. In order to render this machine useful, a couple of grindstones are placed on the cylinder D. Concerning this machine, it is particularly to be considered, whether a sufficient amount of water can be raised again, as has been frequently remarked before about similar works. Figure 152 is said to represent "A Double Water Screw, with Double Pump," and the author observes:

This machine is, on the whole, similar to the preceding ones. The water is discharged from the round or square reservoir A, by B, on the water-wheel C. A continual supply of water for the water-wheel is provided as follows: The crown wheel H is fixed on the upright cylinder M, and is turned by the revolutions of the cylinder, whilst it turns at the same time the upper wheel L, which, acting on the spokes of the double screw K, K, draws up sufficient water by I, I, and then, as stated, discharges it by B, on the wheel C.

The machine may be rendered useful by furnishing the cylinder D with the double crank E, to drive the two pistons of the tubes F, F, which lift the water through the pipes G, G, into the reservoir N, whence it may be carried off for service.

### **John Linley's Hydraulic Device. 1831**

An account of this was published in 1831 in *Mechanics' Magazine*, and is as follows:

32. Perpetual Water-wheels and Pumps (vol. 14, 1831).—A correspondent gives a description of a plan which he says he believes to be entirely original, and not without considerable claims to plausibility, thus:

Let *a b c d* represent a wooden cistern, or trough, half filled with water; E F G, three overshot water-wheels, supported by the upright piece; K is another cistern, or trough, filled with water up to the dotted lines; P is a syphon to convey water from the lower to the upper cistern K; R is a beam supported from the cistern; S T U are moveable cranks attached to the horizontal shafts through the center of the water-wheels—each crank has a connecting-rod to the beam R; V W are two curved spouts to

r«. til.

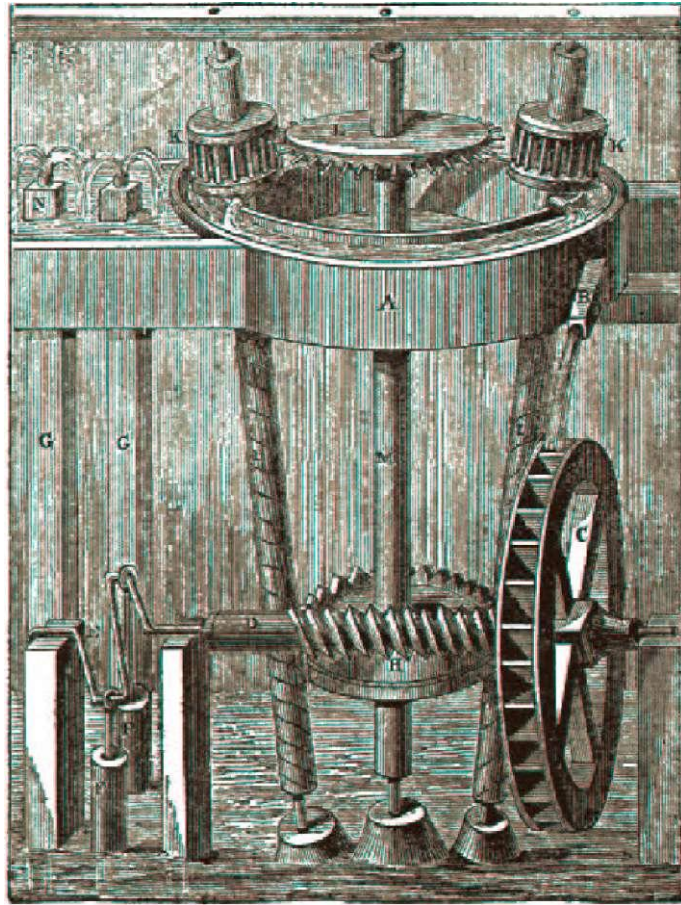

convey water from one wheel to another. It may be well here to premise that each water-wheel has a pump and beam, as only one is seen in the section.

Now, in order to put the machine in motion, it is only necessary to draw a portion of water from the syphon over the wheel E, which immediately revolves, consequently the pump L M draws water from the lower to the upper cistern K. Now, the water passing over the wheel E is collected by spout V, and is conveyed upon the middle wheel F, which also gives motion to another pump, and draws water in like manner. Again, the water passing over the middle wheel, is collected as before by another curved spout W; consequently, the lower wheel is put in action, accompanied with obvious that three water-wheels and three pumps are worked by one stream of water from the syphon. What more is motion? John Linley.

Wicker Sheffield, May 28, 1830.

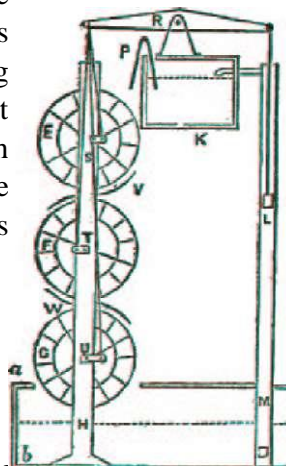

**Device of Author of the**

**"Voice of Reason"**

In 1831 a contributor who signed himself furnished to the scientific journals of claimed was a Perpetual Motion Device said to his credit that he claimed no surplus power for his device— only that it would run itself. He, in fact, stated that his machine could not perform more than the simple operation of pumping its own water.

Author of the "Voice of Reason" England an account of what he invented by him. It should be

The principle upon which he relied is sufficiently shown by the following figure, and the following excerpt from the contributed article:

Observing that persons no less distinguished than Bishop Wilkins, the Marquis of Worcester, etc., have amused themselves with such things as

perpetual motion, it may be some apology for a humble individual residing as I do in a very retired part of the country—scarcely within reach of much society—to confess that by way of a little rational amusement and relief to the mind, I have at times, amid a variety of other investigations and inventions, amused myself amongst the rest, with this of perpetual motion. The result I will, with your permission, lay before your readers. That I trespass upon your pages, you are indebted to your correspondent, Mr. Linley, whose invention I thought might partially lead to an anticipation of one of my own, a model of which I constructed a short time ago. The system which first came to my mind, as likely to lead to the accomplishment of perpetual motion, was that of the syphon; experimenting with which, opened discoveries that might prove useful in hydrostatics. Amongst these was a mode of equalizing the horizontal surface of the water in two separate vessels of different altitudes. The following sketch will afford an idea of my invention.

Let A be a vessel, having two bottom of it, a, and the other open water b, filled to the brim. B, a filled with water as not to come in bottom of the great wheel C, the wood c, attached to the side of crank fixed to the axle of the great which turning moves up and attached to the beam E, which having its cylinder inserted in the upright attached to the upper support for the beam E; the whole, cylinder of the pump, being together by the woodwork ggg.

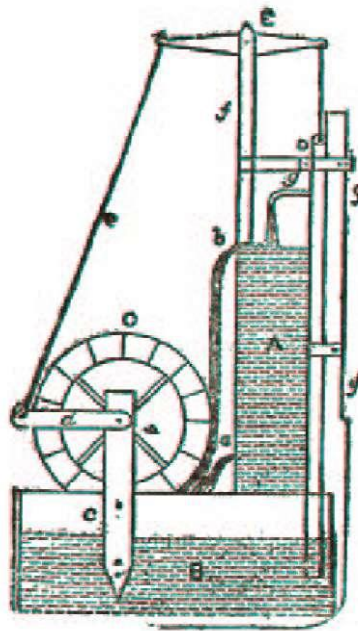

orifices, one at the at the top for waste reservoir, so far contact with the whose axle turns in the reservoir; d, a water- wheel, down the rod e, works the pump D, reservoir B; f an vessel A, to form a together with the supported and tied

To produce the motion, draw the plug from the orifice *a*, from which the water gushing out with considerable force will immediately turn the water-wheel, which communicating motion, by the crank *d* and rod *e*, to the beam *E*, will cause the pump *D* to be worked, the water from the spout passing into the upper vessel *A*. Now, the cylinder of the pump, if one only be used, must be of suitable dimensions, or the velocity of its movement so increased by means of a multiplying-wheel as to enable it to discharge water into the upper vessel *A* faster than the same escapes through the lower orifice *a*; consequently, the vessel *A* will soon overflow from the capacious opening at *b*, to which a trough is attached, which collecting the waste water, causes it to descend also upon the circumference of the water-wheel; thus contributing to its movement, and at the same time tending to preserve an uniform supply of water in the reservoir for the continued action of the pump. Hence you have a perpetual motion, so long as the whole keeps in repair and in good order, which is all that can be expected of any perpetual motion, constructed as it must be of perishable materials.

But of what use are all the perpetual motion machines, if they can perform no other work than that of keeping themselves in motion? For it is evident, in the case of my machine, that if I wish to increase the power of the wheel, fixed as it is in size, radius, etc., I must increase the jet of water, and consequently the pumps must be made of corresponding dimensions, or exert a corresponding increase of force or velocity to replace the water; so that it is evident, neither Mr. Linley's machine nor mine, in their present fixed state, can perform more than the simple operation of pumping their own water.

And this is the case with all the perpetual motion machines I have ever observed they can exert no useful or disposable power beyond that of keeping up an equilibrium, or getting beyond the point of equilibrium.

Yours, etc., AUTHOR OF THE "VOICE OF REASON."  
**An Italian Device**

In 1825 there was published in London in *Mechanics' Magazine* the account of a very ancient invention by an Italian. He had written an account of his invention in Latin. It had been translated and furnished to *Mechanics' Magazine* by a correspondent of that Magazine. The communication so furnished as published is as follows:

The underwritten is translated from an ancient Latin book \* \* \* (entitled "De Simia Nature," Autore Roberto Fludd), which treats of every science known at the time it was published, and largely of the science of mechanics. What followed I have extracted merely to show that the discovery of the perpetual motion was as nearly attained then, perhaps, as it is now. I am, &c., P.

*Of another useful invention for raising water easily, by the which a certain Italian ventured to boast that he had discovered the Perpetual Motion.*

DESCRIPTION OF THE INSTRUMENT.—*A* is an exhauster, or pump.

*B*, a little wheel placed at the bottom of the exhauster, about which pestils, or circular flaps of prepared leather, revolve lightly, so that they rise easily: they are connected by crooked iron.

*C C C*, pestils, or circular leathers, by means of which the water is raised in the pump.

*D*, a wheel, by which the said circular leathers are raised up.

*E*, a pinion, moving the wheels *D* and *B*.

*F* is a wheel, continued from the wheel *G*, whose teeth the pinion *E* propels circularly.

*H*, a pinion moving the wheel *G*.

USE OF THE INSTRUMENT. This instrument is classed with those of the first sort, on which account it is absolutely necessary for a multitude of purposes, because it bears upward a large quantity of water with the least labor; for the number of wheels is not variable; but the length of the receiver A is about the proportion of 35 feet, and its breadth one foot and one-third. The concavities of it should be made exactly round, that they may not lose any water by contracting in their ascension; the

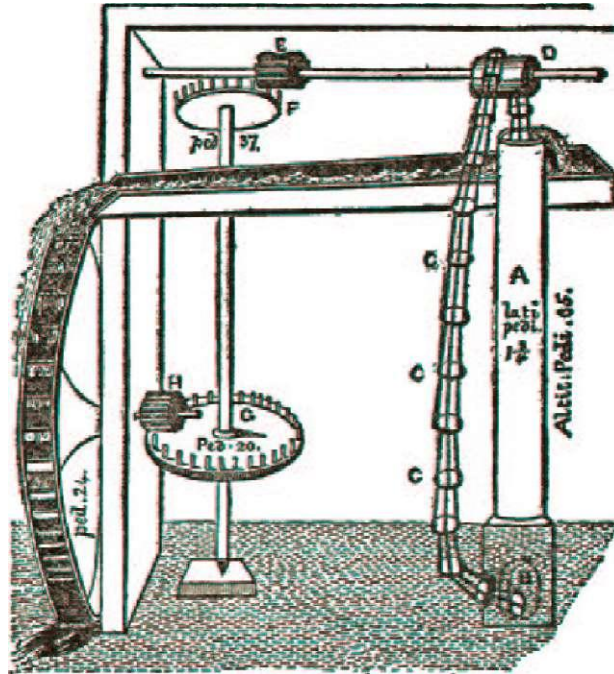

concavity of the pump, therefore, should be perfectly round. The great water-wheel should be 24 feet diameter, and the wheel G 20 feet.

The Italian, deceived by his own thoughts, conceived that as much water would be raised by this pump as would keep the wheel perpetually in motion; because he said that more force was required at the extremity of this machine than at the centre; but because he calculated the proportions of power wrong, he was deceived in practice.

**P. Valentine Stansel's Device. Prior to 1657**

(Exact date not known):

A, B, C is a large cistern of water, above which is another cistern D, E, which is supplied from the lower cistern by the pump X, operated by the water-wheel M, N, the crank L of which is attached by a rod K to the horizontal beam H, I, K, which swings at H, from the side of the upper cistern, as shown at F, G, H. The force-pump X, on the depression of the plunger O, causes the water to rise up the vertical pipe P, Q, R, S, and thence discharge itself into the cistern D, from which a small portion



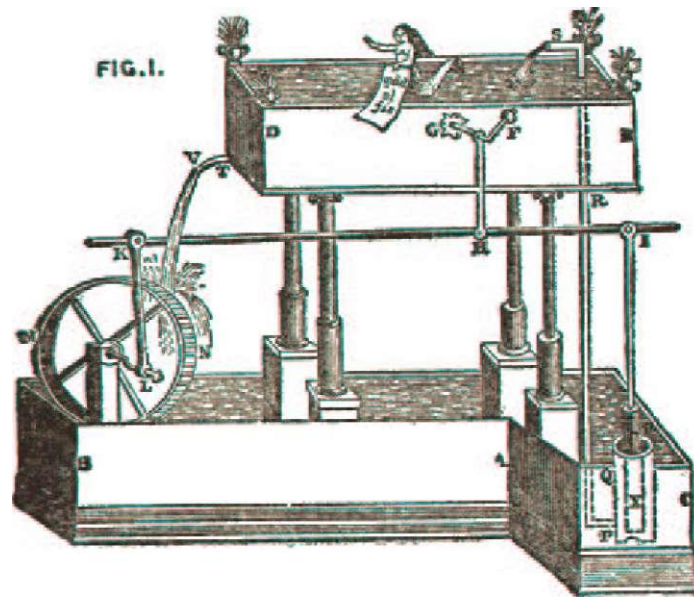

is allowed to escape through the short pipe T, V, whence it falls on the water-wheel, and so on continuously.

**Vogel's**

**Device**

In 1847, A. F. Vogel, of Leipzig, invented

what he called

"Hydrostatic General Mobile."

It was described at the time in a pamphlet, sufficiently illustrated by the following explanation:

A water-wheel, A, B, C, D, raising the water by means of which it is to be operated.

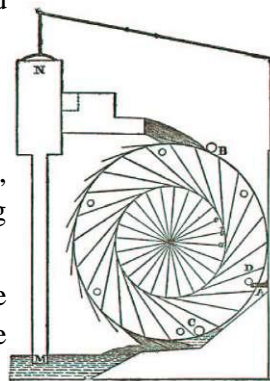

and its operation is annexed figure and

This is effected, he supposes, by the wheel acting at A, by the pressure of one of six pins D, on a vertical rod, attached to a horizontal beam, working on a centre, and its opposite end being secured to the pump-rod of the barrel M, N. The projector has an idea that by means of flaps, which close the cells of the wheel as they pass under rollers at B, while at C there is a similar contrivance to open the flaps and let out the water, and therefore by its retention on the descending side it will become more effective in turning the wheel.

### A Water Wheel-Driven Pump

This device is claimed by the writer to be an adaptation of Rangely's Patent Roller Pump. A description by the writer, whose name is not given, was published in *Mechanics' Magazine*, 1823, in the following language:

49

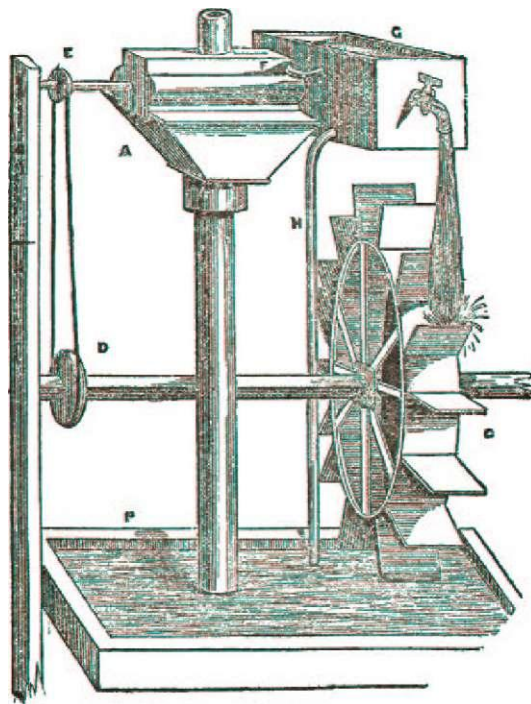

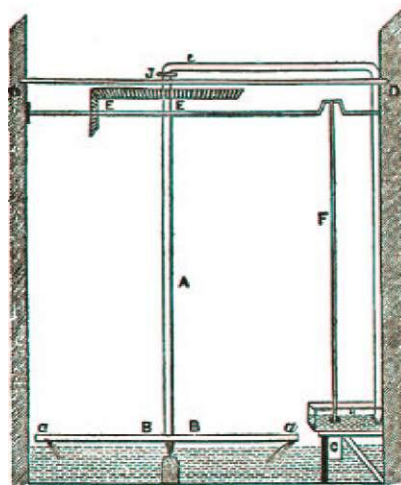

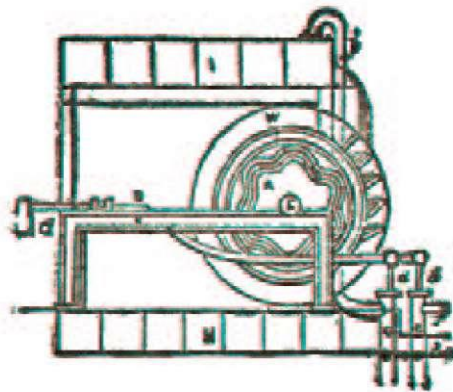

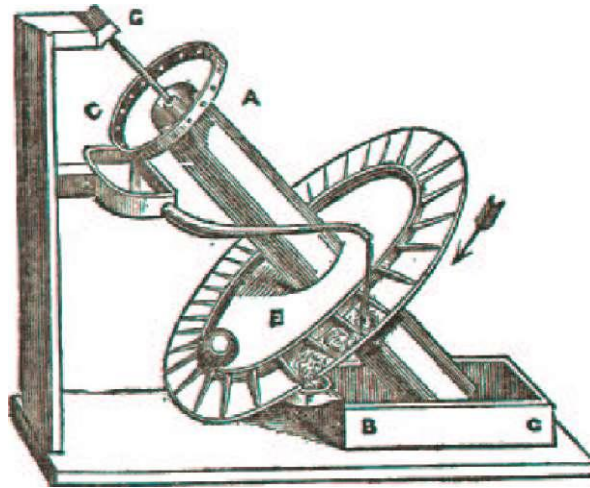

which, when the screw is turned round, receives the mercury which falls from the top; D is a pipe, which by the force of gravity conveys the mercury from the reservoir C on to (what, for want of a better term, may be called) the float-board E, fixed at right angles to the centre of the screw, and furnished at its circumference with ridges or floats to intercept the mercury, the moment and weight of which will cause the float-board and screw to revolve, until, by the proper inclination of the floats, the mercury falls into the receiver F, from whence it again falls by its spout into the cistern G, where the constant revolution of the screw takes it up again as before.

To overcome this (the power of the fluid in the screw to turn it backwards), I thought of placing a metallic ball, or some mercury, on the ledge above the floats (as at H in the drawing), of just so much weight, and no more, as would exactly neutralize this backward endeavor; whether or no this would increase the difficulty of raising the mercury in the screw I cannot say, having never tried the experiment.

### John Sims's Problem. 1830

John Sims, a Welshman, furnished the following suggested device to "Mechanics' Magazine" in 1830:

Let us suppose an apparatus to be constructed of the description represented in the annexed engraving: *a* is a water cistern, whence water is

to be raised by the pump *b*, to supply the cistern; *c d* is a small pipe with a stop-cock at *e*, which lets the water from cistern *c* into a strong water-tight bellows *f*. The bellows have no valve, but a cock *g* to let out the water into cistern *a*; *h* is a weight, and *i* a rack on the top of the bellows which works in the cogs on the axle of the large cog-wheel *j*; *j* turns the little cog-wheel *k*, that gives motion to the arm *l*, and works the pump-handle *m*; *n* is an upright rod on the end of the lever *o*, which rod has a turn at *p* and *q* for the top of the bellows to press against in ascending and descending. The water being let into the bellows from the pipe *d*, will cause the top of the bellows, with the weight and rack, to ascend till the former reaches and presses *p*, which will move the lever *o* and the arm or rod *c*, by which means the stop-cock *e* of the pipe will be shut, and the cock *g* opened, and the water let in from the bellows into the cistern *a*. The top of the bellows will now descend till it comes down and presses the turn *q*, which will again shut the cock *g* and open *e*, on which the water will again flow from the pipe into the bellows, and cause the top with the rack to ascend.

Now it is generally known that the power of an hydrostatic bellows is thus calculated:

As the area of the orifice or section of the pipe,

To the area of the bellows:

The weight of water in the pipe is,

To the weight the bellows will sustain on the top-board.

We will suppose, therefore, the high, with a bore equal to 1 would give

pipe *d* to be 10 feet square inch, which

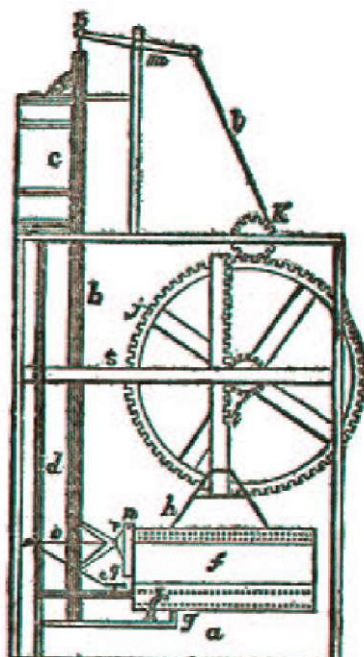

120 cubic inches, and about  $4\frac{1}{4}$  lbs. of water. Let us suppose, also, the boards of the bellows to be 20 inches square, which gives 400 square inches. When the water is let from the pipe into the bellows, there will be a pressure of  $4\frac{1}{4}$  lbs. on every square inch, which on the whole will amount to 1,700 lbs. Now take half of this force and place it on the top of the bellows; there will then be a working power of 850 lbs. up and down, and allowing the bellows to raise one foot, it will contain about 20 gallons of water. Now the question is, will not the machinery, with a moving power of 2 feet and 850 lbs., raise 20 gallons of water 10 feet, which would, of course, cause the motion to be perpetual?—JOHN SIMS.

Pwllheli, North Wales, Dec. 11, 1829.

The foregoing device brought from another correspondent the following:

Had Mr. Sims gained the power exerted by the descending weight on his bellows, he would have been fortunate indeed; but it unfortunately happens that its returning power (or an equivalent) was expended in raising it.

With respect to his question, whether a circulation of water would be kept up by the arrangement, I answer, no; as the velocities will be in the inverse ratios to the forces, and the descending column of 120 inches must expend itself forty times to raise the ascending one to the height of twelve inches, as proposed:—

10 ft. or 120 in.  $\times 40 = 4,800$ , lifting force or power.

400 in.  $\times 12 = 4,800$ , opposing force, resistance, or weight.

Here is an equilibrium, and nothing gained to overcome friction or the weight of the atmosphere on the piston of the pump. Were it possible to annihilate both friction and atmospheric weight, even then, unless the power exceed the weight, the power would not be a moving one.

### **A Perpetual Pump, by an Unknown Inventor**

In Volume I of "Mechanics' Magazine." 1823, appears an account by a correspondent of a Perpetual Motion device which is illustrated by the figure, and the quotations following:

*a b c d* is the section of the reservoir, &c., showing the wheel, the pump, &c. *A B* is an overshot water-wheel; *C D* the working beam; *E* the pump; *F* a pipe from the top of the pump, through which the water was to fall upon the wheel; *C G* an arm, communicating, by means of a crank attached to an horizontal shaft through the centre of the wheel, motion to the lever or working beam, and so raising water from the reservoir by means of the pump; *H I* the water. It was supposed that the water which had fallen upon the wheel into the reservoir would be raised by means of the pump, fall through the horizontal pipe, and so produce a continued rotary motion.

The persistence of Perpetual Motion workers is amusingly illustrated by the

**a**

inventions of William Willcocks Sleigh and Burrowes Willcocks Arthur Sleigh. Their devices were so extremely complicated and not

susceptible of being mentioned rather than

In 1845, William doctor of medicine and Middlesex, England, British Patent on what

"A Hydro-mechanic motive power."

He took out other hydro-mechanical and 1860. Then in 1864, Willcocks Arthur Sleigh similar devices, and patent.

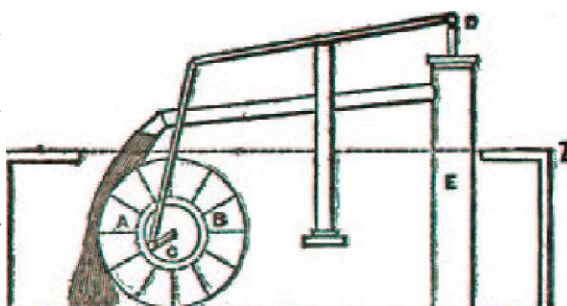

understood, and hence are shown in this work.

Willcocks Sleigh, a surgery, of Chiswick, applied for and obtained he called

apparatus for producing

patents on devices in 1853, 1856, his son, Burrowes took out two patents on then in 1866, still another

The specifications for each of the above mentioned patents are lengthy and detailed. The inventors evidently had the greatest confidence in their efforts, though surely they never put them to actual test. They seemed to have been mechanically stupid, and incapable of correct mechanical thinking, but their efforts were so tireless and so earnest that we sub

mit that the Sleigh family had done its full, fair share in the efforts to accomplish Self-Motive power.

Equally amusing are the efforts of James Smith of Seaforth, Liverpool, and Sidney Arthur Chease, Liverpool, gentlemen: These two colaborers applied for British patents on four different Hydro-mechanical devices— one in 1858, two in 1863, and one in 1865. On three they obtained patents, and on the other one provincial protection. One of them seems to have been a capitalist, and the other one a machinist. Their models were complicated beyond understanding, and apparently they were laboring in the dark without intelligent plan. They seemed to have thought that when a complicated mess of machinery parts and fluid were assembled Perpetual Motion must somehow result.

Nothing could be gained by setting forth their inventions fully, but their labors were so great, and their efforts so intense that we feel like preserving their names from oblivion, and hence we give them mention here.

### **Why Hydraulic and Hydro-Mechanical Devices for Obtaining Perpetual Motion Failed to Work**

Next to wheels and weights, the use of liquids in a hydraulic, hydrostatic, or hydro-mechanical manner have been sought to be utilized by Perpetual Motion seekers as a means of obtaining energy from the machine not supplied to the machine. The foregoing are only a few of the many devices of that kind, but they are the most simple of those that have been brought to light, and consequently better illustrate the manner in which it has been sought to utilize the interesting properties of liquid pressure and mobility in the solution of the problem.

An examination of the preceding devices discloses that in each case the inventor sought by the energy of the descent of a liquid to elevate through the same distance of ascent the same or a greater quantity of the same liquid, or in some cases to obtain from the pressure of a liquid a greater force than is required to expand a bag, bellows or vessel, submerged the same distance below the level.

The impossibility of all of these schemes is apparent from the same reasoning that is applied to illustrate and show the impossibility of ob-

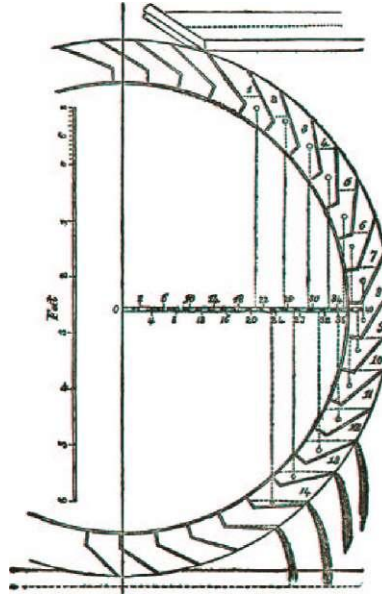

No.	Lbs. .	No.	Lbs.
1	21 1/2 .	.8	40
2	26 1/4 .	.9	39 1/2
3	30 1/2 .	.10	38
4	33 3/4 .	.11	35 3/4
5	36 3/4 .	.12	32 1/2
6	38 2/4 .	.12	21
7	39 3/4 .	.14	12

I am induced to make an attempt to demonstrate the utter impossibility, under any circumstances, of making a water-wheel that will supply itself instead of having any surplus power.

The accompanying drawing represents part of an overshot wheel in section, the buckets only part filled, by which the whole of the water expended continues to act through a greater portion of the circumference than it otherwise would do. The area of the vertical section of the complement of water to each bucket is made 40 inches; and taking the breadth of the wheel at, say 28 2-3 inches, gives 40 lbs. as the weight of water in each bucket; therefore, as there are 12 buckets containing 40 lbs. each, No. 13 30 lbs., and No. 14 only 20 lbs., altogether making a total of 530 lbs. acting on the wheel at the same time; to show clearly all the effect that can be expected from this, I have divided the horizontal radius into a scale of 40 equal parts (there being 40 lbs. in each bucket); and from the gravitating centre of the fluid contained in each is drawn a perpendicular to the scale, where the effective force, or weight in each bucket, may be read off as on the arm of a common steelyard. The weights will be found as follows, viz:—

2

6109.09 answer in lbs.

So that for every 1008 gallons expended on the wheel, we only gain sufficient power to supply 611 nearly.

See also Chap. XV, Bishop Wilkin's Work, appearing at page 297 et seq. supra.

It is therefore quite evident that, although we have 530 lbs. acting on one side of the wheel, a column of water weighing 446 lbs. reacting at the same distance from the centre, on the opposite side, will exactly balance the whole 530 lbs. contained in the buckets; so that about a sixth of the expenditure rests on the axis without producing any useful effect, and the wheel so loaded must remain in a state of rest. Now, in spite of friction and the *vis inertia* of matter, if we suppose the wheel at work, it can raise only 446 lbs. at the expense of 530 lbs.; but even if it could raise the whole 530 lbs., we should then be but little nearer the mark, for we must remember that the gravitating centre of our power falls through a space of only 8 ft. 11 in., while the water must be raised at least 11 ft. before it could be laid on and delivered clear of the wheel.

As a further means of coming at the end I had in view at the commencement of this letter, I will conclude with a simple rule for calculating the quantity of water a wheel of this kind will raise:—Multiply the number of pounds expended in a minute by the height or diameter of the wheel in feet, divide the product by the height (also in feet) of the reservoir to be filled, and two-thirds of the quotient will be the answer required. Example, for the wheel above described, making six revolutions per minute:—

42 buckets on wheel.  
6 revolutions per minute.

252 buckets filled per minute. 40 the weight of water in each bucket.

10080 lbs. expended per minute. 10 feet height of wheel.

11)100800 momentum, dividing by 11 feet as the height of reservoir.

## Chapter IV

### PNEUMATIC, SIPHON AND HYDROPNEUMATIC DEVICES

#### The Hydrostatical Paradox

Next to the wheel with levers and weights, we believe this simple Hydro- statical Paradox has more frequently occurred to mechanical and scientific tyros as a means whereby it was hoped to attain Perpetual Motion. There is no record that we know of of the name of anyone who has ever attempted it, and, yet, the instances are doubtless myriads.

The author believes he has heard dozens of young persons mention it as a means of obtaining a continuous flow of water.

In 1828, Niel Arnott, M. D., published the third edition of his "Elements of Physics, or Natural Philosophy." At page 141 under the subject of "Mechanics" he comments generally on the subject of Perpetual Motion, and says:

What an infinity of vain schemes—some of them displaying great ingenuity— for perpetual motions, and new mechanical engines of power, etc., would have been checked at once, had the great truth been generally understood, that no form or combination of machinery ever did or ever can increase, in the slightest degree, the quantity of power applied. Ignorance of this is the hinge on which most of the dreams of mechanical pro-

jectors have turned. No year passes, even now, in which many patents are not taken out for such supposed discoveries; and the deluded individuals, after selling perhaps even their household goods to obtain the means of securing the supposed advantages, often sink in despair, when their attempts, instead of bringing riches and happiness to their families, end in disappointment and utter ruin. The frequency and eagerness and

obstinacy with which even talented individuals, owing to their imperfect knowledge of this part of natural philosophy, have engaged in such undertakings, is a remarkable phenomenon in human nature.

At page 270 in treating on "Hydrostatics," he says:

A projector thought that the vessel of his resented here, was to solve the renowned petual motion. It was goblet- shaped, towards the bottom until it became a tube, and pointing with an open extremity into reasoned thus: A pint of water in the goblet a must more than counterbalance an ounce must therefore be constantly pushing the at *a*, and keeping up a stream or circulation, water dries up. He was confounded when a *a* and in *b*.

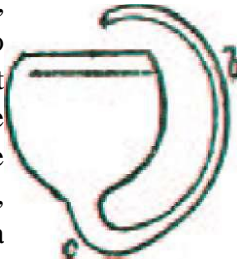

contrivance, rep-  
problem of the per-  
lessening gradually  
bent upwards at *c*,  
the goblet again. He

which the tube *b* will contain, and  
ounce forward into the vessel again  
which will cease only when the  
trial showed him the same level in

### Pickering's Device

In 1858, Peter Pickering, Landed Proprietor of Danzig, Prussia, applied for a British patent on "An Atmospheric Engine."

It may be described as fol-  
1, 2, 3, 4, 5, are cylinders 18  
and 3 feet diameter, so that  
each piston has 1,296 square  
with an atmospheric pressure  
square inch, causes a

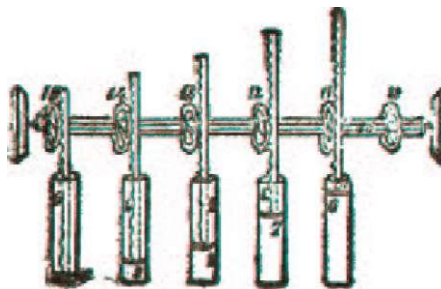

lows:  
feet long or high  
the surface of  
inches acting  
of 15 lbs. to the  
pressure of

19,440 lbs. to each cylinder (saying nothing of friction, which will be accounted for later) ; 6, 7, 8, 9, 10, pistons of each cylinder, as they must be placed when the engine begins to work; 6, 7, 8, 9, causing a vacuum under each piston (as they have for the first time been brought into their present situation by main force), afterwards, when the engine is permitted to start, they will regulate themselves; No. 10 lies flat on the bottom of the cylinder; 11, 12, 13, 14, 15, piston rods acting on shaft No. 16; 17, wheel to communicate the engine's power to the machinery of the engine itself; 18, wheel to communicate the engine's power to the wheel or propelling screw of a ship, manufactory, locomotive, etc.

### Stuckey's Device

In 1842, William Henry Stuckey, Esquire, of St. Petersburg, applied for a British patent on "A Pneumatic Engine for Producing Motive Power."

His specifications describe his alleged invention as follows:

Fig. 1 is a front view of my said pneumatic engine, partly in section.

<sup>A<sup>1</sup></sup> and B<sup>1</sup> cylinders, united at their extremities *a, a*, which gudgeons that have their in the upright standards D, two pistons which work to cylinders; E<sup>1</sup> and E<sup>3</sup> two tubes which radiate from the E<sup>2</sup>, E<sup>4</sup>, two similar arms or radiate in opposite di- the cylinder B<sup>1</sup>, each an open communication tubes attached to it. F<sup>1</sup>, F<sup>2</sup>, other cylinders, affixed to a R, open at top to the atmosphere, and open at bottom to the radial tubes E<sup>1</sup>, E<sup>2</sup>, E<sup>3</sup>, E<sup>4</sup>, connected with them at their outer extremities. G<sup>1</sup>, G<sup>2</sup>, G<sup>3</sup>, G<sup>4</sup>, pistons working in the cylinders F<sup>1</sup>, F<sup>2</sup>, F<sup>3</sup>, and F<sup>4</sup>, and H<sup>1</sup>,

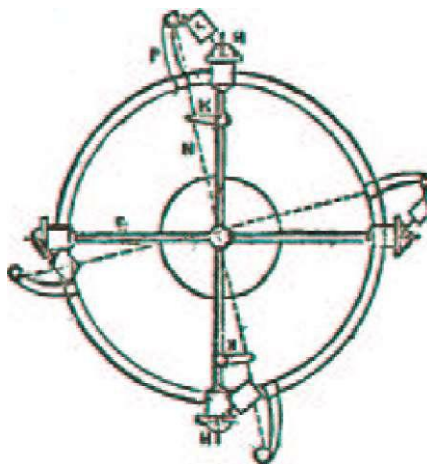

two horizontal inner rotate on bearings C, C, D; A<sup>2</sup> and B<sup>2</sup> and fro in these hollow arms or cylinder A<sup>1</sup>, and tubes which rections from cylinder having with the arms or F<sup>3</sup>, and F<sup>4</sup>, four circular ring R,

R, open at top to the atmosphere, and open at bottom to the radial tubes E<sup>1</sup>, E<sup>2</sup>, E<sup>3</sup>, E<sup>4</sup>, connected with them at their outer extremities. G<sup>1</sup>, G<sup>2</sup>, G<sup>3</sup>, G<sup>4</sup>, pistons working in the cylinders F<sup>1</sup>, F<sup>2</sup>, F<sup>3</sup>, and F<sup>4</sup>, and H<sup>1</sup>,

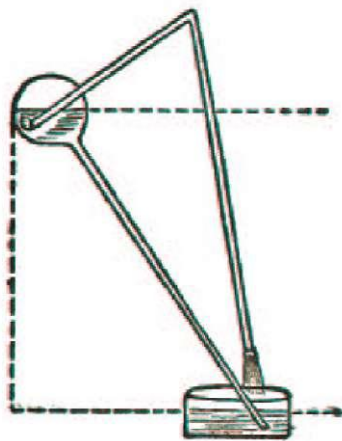

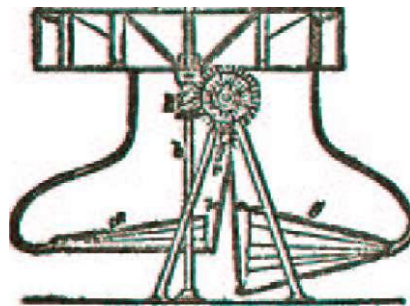

What I claim as my peculiar right is, the impulsion of a current of air against the fans of a drum (as that at *c*) through pipes, as at *d* and *e*, for the purposes of a motive power, together with a certain arrangement of mechanism, by means of which the action first induced shall be kept up.

### Laserson's Device

In 1860 Marc Antoine F. Mennons, of Paris, applied on behalf of Louis Diodor Laserson of Moscow, Russia, for, and obtained, a British patent on

"Certain Improvements in the Production of Motive Power, and in the Apparatus Connected Therewith."

He described the essentials of his device as follows:

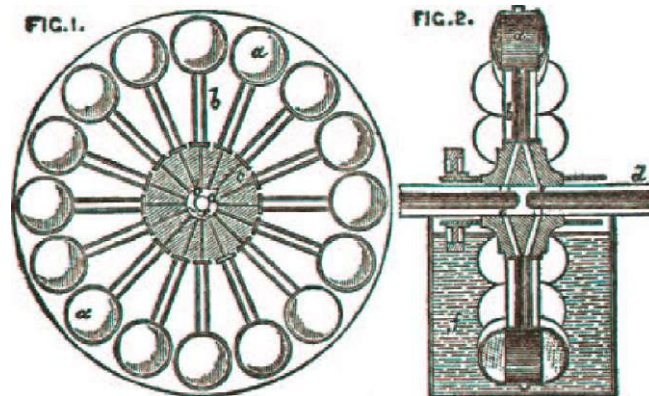

The invention consists in the application of the ascensional force of air or gases developed under water to the generation of motive power, and in the combination of apparatus, by means of which the power thus produced is accumulated, transmitted and applied. The principal element of this combination is a wheel or disc (shown in plan and section, Figs. 1, 2), the dimensions of which are proportioned to the power required. On the circumference of this wheel are fixed at equal distances a given number (say sixteen) of flexible air reservoirs *a*, communicating with an equal number of tubular passages *b*, which open in the nave *c*. In the length of the fixed shaft *d*, on which this wheel is mounted, are formed two cylindrical cells *E* by which the air is admitted to and discharged from the flexible reservoirs *a* by the tubular passages *b*, with which they correspond. The hydro-atmospheric wheel thus mounted and immersed to the required depth in a suitable reservoir as in *f*, is placed in communication by its hollow shaft with an air-compressing apparatus of any convenient form, which in its turn is connected with the shaft of an ordinary hydraulic wheel. The latter being set in motion acts on the forcing apparatus, by which a jet of compressed air is thrown into the hollow shaft of the hydro-atmospheric wheel by the entry cell corresponding with the orifices of the fourth quadrant or lowest immersed section of the latter. The air injected following the tubular passages within its range enters and inflates the corresponding flexible reservoirs, which thus acquiring an ascensional force proportioned to their displacing capacity and degree of immersion, carry forward the wheel in their movement towards the surface. On reaching the water line the tubular passage come into communication by the nave orifices with the discharge cell of the fixed shaft, and give egress to the air compressed in the flexible reservoirs, which collapse simultaneously with the inflation of the succeeding series by which they have in the meantime been replaced in the fourth quadrant. The latter following the ascensional movement of their predecessors give place to a third series, and collapse in the same way on passing the

surface, so that each air reservoir on re-entering the water in the continued revolution of the wheel presents comparatively little resistance until it arrives at the turning point, when the communication with the entry cell of the axle being again established the movements above described are reproduced. The force thus developed by the hydro-atmospheric wheel, which represents about three times that of the prime motor, may be at this stage applied to the required transmissions of movement. When natural watercourses are not to be had within a reasonable distance of the locality in which the force is to be applied, it becomes necessary to replace them by an artificial fall.

### **Von Rathen and Ellis's Device**

In 1866 Anthony Bernhard Baron Von Rathen and George Henry Ellis, both of London, applied for and obtained British patent on

"A New or Improved Mode of Constructing a Motive-power Wheel Whereby to Obtain Permanent Motion by the Application of Compressed Air or any other Elastic Fluid."

In the specifications for patent the essentials of their invention are described as follows:

This invention may be considered supplementary to an invention of the Baron Von Rathen of an elementary motive-power engine, for which a patent has been granted to him, No. 818, and dated March 23, 1865, and consisting in a newly-discovered plan for the construction of a motive-power wheel or engine, on the principle that the motor, consisting of compressed air or other elastic fluid, is maintained in permanent activity and without removal or renewal, and the useful resistance of the air in the chambers is on the surface of a fixed cylinder, the motion is regular and direct, the wheel rotating on its fixed central axis.

The nature of our present invention consists principally in our providing, instead of that a motive-power wheel having its axis upon fixed bearings in an eccentric position and turning in an oscillating cylinder. The motor being brought through a hollow shaft, or any convenient channel, is introduced into one or more closed chambers formed upon the longest arm of the power wheel for the purpose of driving it round; by this means, according to the uniform pressure of the elastic fluid upon all surfaces, we obtain not only a continuous but an additional degree of driving power from the leverage given by the position of the wheel. There is, as shown in Fig. 1 of the accompanying drawing, a fixed arm or driving rod fixed upon the cylinder by which to impart motion to a crank, piston, or other apparatus. We propose to obtain the motor by pumps worked by or in connection with the power wheel, and having other suitable and necessary appliances for regulating, storing, transmitting, and manipulating the force supplied to or communicated by the power wheel, as have been described, to be applied with the plan for working the elementary motive-power engine hereinbefore referred to.

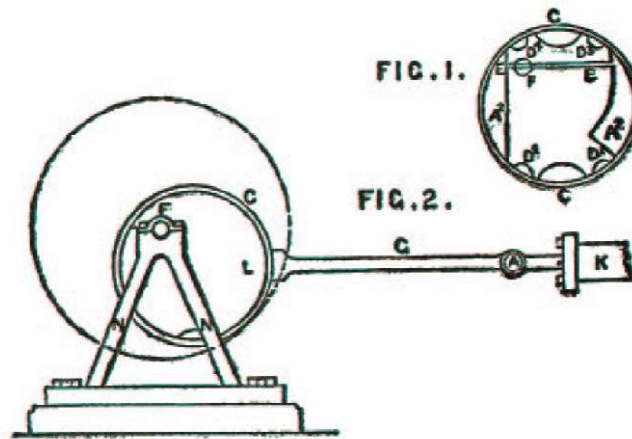

Fig. 1 is a vertical section of the power wheel revolving inside and moving the oscillating cylinder.  $A^1$  and  $A^2$  are air-tight chambers, the former being the driving chamber and the latter intended to check or counterbalance its wedging or binding effect upon the cylinder, owing to the extra leverage obtained and the pressure upon the surface of the rod B, the wheel will revolve in that direction by the action of the elastic force which finds its useful resistance on the internal surface of the cylinder C.  $D^1$ ,  $D^2$ ,  $D^3$ ,  $D^4$ , are packings to render the two chambers air-tight and to afford bearings for the four arms of the wheel upon the cylinder; E, E, are two tubes for conducting the motor into the chambers, and F is the axle, upon which the wheel is firmly fixed and driven round with it.

Fig. 2 is a side elevation of the power wheel. F is the hollow shaft or axle through which the motor passes from the pumps or reservoir in connection therewith, and upon which the wheel rotates; G is the rod or arm fixed at one end to the cylinder C, and attached at the other end by a joint or coupling H to the rod I, acting within a cylinder to give motion to the piston K; L is one of the side covers of the power wheel, and N the support or framework for the wheel.

### Richard Varley's Device

In 1797 Richard Varley, of Damside, Lancashire, England, a merchant, applied for and obtained a British patent on

"A New Perpetual Moving Power."

His device is explained by the following excerpt from his application:

"My invention consists of a method of applying the weight of the atmosphere upon a wheel in any other fluid, and by that means destroying its spring or reaction, the manner of doing which I describe as follows, agreeable to the drawing (Fig. 6) annexed:

"A is a circular vessel, made of copper or any other substance, capable of containing water, and covered with a top part so as to be perfectly airtight. B is a wheel placed in the inside of the vessel, with its axle perpendicular, the uppermost part of which comes through the top of the vessel, and is made to work air-tight; the lower end runs in a step within the vessel, and no part of the wheel is to touch the vessel but its axis. C is a cylinder placed firmly upon the wheel. D is the piston, suspended by a chain to a strong spring fixed on the wheel. This spring is to be

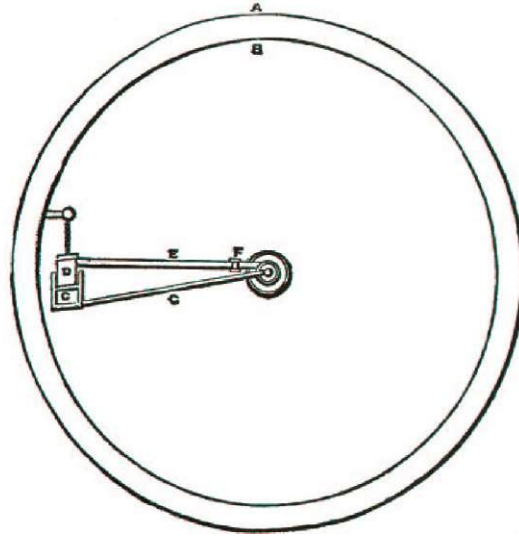

made of such strength as that when the whole weight of the atmosphere is upon the piston the air will only move it about one inch down. E is the tube leading from the axle, which is hollow from the top to the level of the wheel, so as to admit the external air by this tube to the piston D, which piston is a circular vessel, made air-tight, and exactly fits the cylinder. There is a joint in the tube E at F, which is made air-tight by leathers, so that when the piston descends the tube may give way to it. G is a small tube leading from the bottom of the cylinder to the center of the axle, and from thence brought out at the end of it, and by which the air is extracted from the cylinder by means of an air pump and a vacuum formed in it. On the top part or any other convenient place of the vessel, are fixed two cylinders or tubes of a proportional size to the cylinders on the wheel, one of which is a condensing cylinder, by means of a screw and piston, and by which the water in the vessel may be compressed; the other has its piston suspended at the bottom, and the top part of the cylinder being filled with air as the other piston is screwed down this rises, and condenses the air in the cylinder, the spring of which keeps the water in the vessel pressed to all parts alike; and when the air is extracted from the cylinder C and the piston D is forced down by the external atmosphere into the cylinder, this pressure is continued, and the condensed air expands in proportion and prevents any tendency to a vacuum being formed, which would cause a cohesion of all the parts. By this means the external air is suspended upon the wheel by the chain, the same as a weight, and the spring of the atmosphere being taken from



the cylinder there is nothing to oppose this water; and this power may be increased in number of cylinders on the wheel and its diameter."

weight, there being no spring in proportion to the size and

### Siphon and Funnel Device

This was the work of an Englishman whose name is unknown. An account of it appeared in "Mechanics' Magazine," 1828, in the following language:

*a* is a circular glass vessel 1 foot 6 inches diameter; *b b* a tube fixed thereunto; *c c* are funnels containing valves; *d*, a float of hollow copper, or any light substance; *e*, an open mouth; *f*, an open vessel filled with mercury as high as the dotted line.

It is well known that several experiments were made by M. Venturi, Sir Isaac Newton, etc., demonstrating that a vessel shaped thus— will emit water with a much greater rapidity than a vessel shaped thus—say, with more than a third as much speed. I propose, then, to have the mouth of the vessel *a* of the former shape, being the natural form of flowing water. The vessel *a*, and tube *b*, must be completely filled with mercury, by means of the funnels *c c*, which will also contain mercury. In order to set the fluid in motion, the valve in the large vessel *c* is to be raised; the mercury (which was hitherto held up by a greater weight of atmosphere) will instantly run out of the mouth *e*, and must be suffered to do so till the mercury in *c* is level with the dotted line; by this time the mercury in *a* will have obtained a momentum which will be more than equivalent to the pressure of the atmosphere: consequently, the mercury will run out of the large vessel *a*, till it falls as low as the dotted line; the float *d*, resting on the mercury, of course, falls with it, opens the valve, and admits a proportionable quantity of mercury through the tube *b*, driven by the pressure of the atmosphere (the height from the mercury in *f*, to

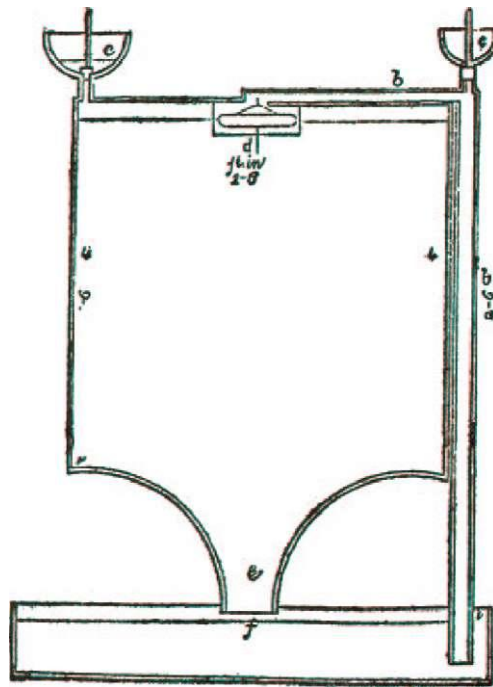

the top of the tube b, being only 26 inches, which is 2 inches less than what the atmosphere will at all times raise mercury in a vacuum).

By this means will there not be a continual circulation of mercury?

### Orchard's Vacuum Engine

In 1826 there was published in "Mechanics' Magazine," London, a communication from a Mr. Orchard, concerning an invention he considered himself as having made. The account is published in his own words, and is as follows:

A is an iron reservoir nearly filled with mercury; B, a tube twenty-four inches long, having its lower end inserted in that reservoir; and C and D, two cocks for the convenience of filling the tube B. From this another tube M proceeds at right angles, to the vessel G. In this latter tube is the cock F, to admit of, or shut off, a communication between the tube and the vessel G. This communication being closed, the tube B is carefully filled with mercury; after which the cock D is closed and the cap E screwed on.

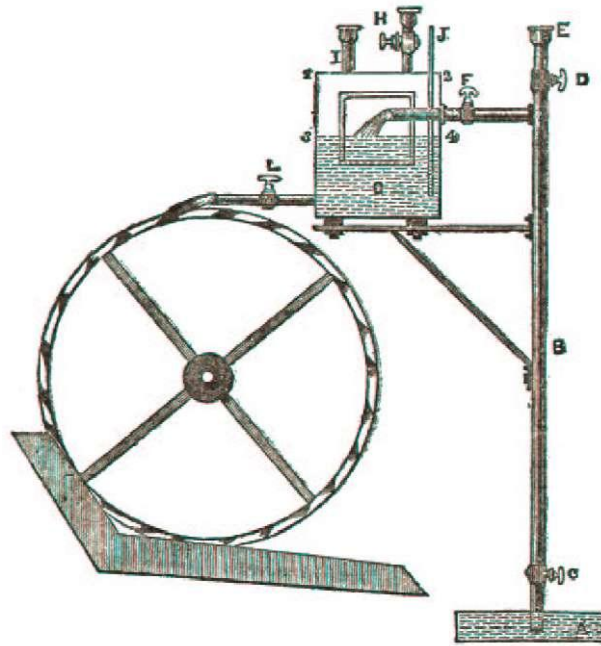

The vessel G is to be filled with mercury through the cock H, the pipe I being open to allow of the escape of air. When this vessel has been filled, the cock H should be closed and its cap screwed on; and the pipe I be also closed by a valve, which is to be pressed tight by the cap on the head of the pipe. I is a vent-pipe, open at the top. The space represented by the double lines is a panel of thick plate glass having two horizontal lines described on its surface, whereby the attendant may observe the quantity of mercury within the vessel.

The cock F being closed, a quantity of mercury must be allowed to run out of the vessel G, equal to the space 1, 2, 3, 4, which space will become a vacuum. If, therefore, the cock L be then opened, to allow of the discharge of a certain quantity of mercury on the wheel, and the cocks C and L also opened, the mercury will continually rise from the reservoir A into the vessel G, and thence be discharged on the wheel, whence it will again fall into the vessel A, to keep up the supply. The cock F must be so adjusted as to admit into the vessel G a quantity of mercury equal to that which is discharged by the cock L. This can be ascertained and regulated by means of the panel of glass above described.

The specific gravity of mercury being  $7\frac{3}{4}$  ounces, it is evident that but a small quantity of it is required to turn the wheel, which has no friction but that of the axis on which it turns.

---

3 purpose to derive a disposable force or power from the action, weight or pressure of the atmosphere, through the medium of the column of water or other heavy liquid descending on one side of the enclosed vertical wheel, and from thence through the centrifugal wheel, being returned into the same reservoir from which the pressure of the atmosphere raises it to be again delivered on the top of the vertical wheel to supply the discharge on the descending side, arising from the centrifugal force communicated to it by the rotary velocity of the centrifugal wheel, and the pressure of the descending column over-balancing the reaction or resistance of the atmosphere at the discharging apertures of the centrifugal wheel. Thus a small quantity of water or other liquid (according to the size of the machine required) being continually returned onto the top of the vertical wheel by the pressure or action of the atmosphere, and acting by its unbalanced gravity or impetus in its descent, will produce a disposable force or power of any required magnitude, by increasing the size or number of the machines, provided the height the fluid is required to be raised is not quite so high as the column which the atmosphere, when lightest, will raise of that fluid, and allowing for the requisite velocity on the vertical wheel. In Fig. 1, A is the feeding pipe through which the fluid is raised by the pressure or action of the atmosphere on the fluid in the lowest reservoir in which the lower end of the pipe is

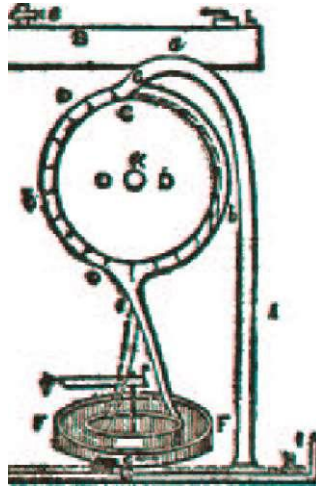

immersed, closed by a cock, sliding plate, valve or shutter, to allow the machine to be filled at the commencement, and which may be under the surface of the fluid, also to keep it air-tight. The other end is inserted air-tight into the top reservoir, or by a curve, as shown by the dotted line *a*, joined to pipe *C*, and delivering upon the vertical wheel, without any top reservoir. In this case, if water is used, the highest part of the bend or curve inside should not exceed thirty feet above the level of the water in lowest reservoir. *B* is the top reservoir, the lowest internal part of which should never exceed twenty-nine or thirty feet above the water in lowest reservoir, but it will admit the top of the reservoir, if wished, to be rather higher than when the curved tube *a* only is used. It must be quite air-tight, and supported as convenient. *C* is a pipe, joined air-tight to top reservoir, or forming part of *A*, *a*, *C*. *C* is a movable flap of strong leather, or other substance, which may be joined to the lowest part of *C*, where the water is delivered so high on the wheel and where floats with hinges are used on the wheel to prevent its going down on the ascending side; but not necessary when water is delivered lower on the wheel. *D*, *D*, *D*, *D*, is the fixed and immovable waterway, and the fixed case or cover (of the vertical wheel), of which it is a part, joining also the stuffing boxes, through which the axle of the vertical wheel moves air-tight, thus entirely enclosing and surrounding every part of the wheel but the projections of the axle, and allowing the float boards and wheel just to turn freely in it without touching in any part except the axle in turning in the packing of the stuffing boxes; the float boards are fastened on to the iron rim or sole of the vertical wheel by very strong hinges or movable joints just within the fixed waterway *D*. *E* is a pipe or pipes joined air-tight to the fixed cover or case enclosing the vertical wheel where the water is to be taken off it, having their lower ends inserted air-tight also into the bottom of the fixed and immovable top of the centrifugal wheel in such a direction that they may deliver the water into the move-able waterway of the centrifugal wheel as near as possible in the same direction as the water circulates in the wheel. *F*, *F*, is the centrifugal wheel, of any diameter convenient, according to the size of the machine, placed horizontally above the fluid in the lowest reservoir, so as to move on its axis as near as possible to the surface of the fluid without touching it, having an immovable cover or top, leaving a hollow waterway round the rim, into which the fluid is discharged from *E* in the direction of the wheels' motion. *G*, *G*, are the discharging apertures of the centrifugal wheel. *H*, *H*, is the surface of the fluid in *I*, *I*, the lowest reservoir, containing a sufficient quantity of water when the machine is put to work, to allow the bottom of feeding pipe *A* to be immersed in it at least two feet below the surface, or a greater depth may be given to that part of the reservoir under the mouth of pipe *A*, forming a sort of well in which *A* may be inserted any required depth, better to exclude any particles of air or bubbles mixed with the water nearer its surface from ascending in pipe *A*. This reservoir should be large enough to contain the whole of the water used before the machine is filled. *K*, *K*, are the ends of the axle of vertical wheel outside of the stuffing boxes of the fixed case, and are the only parts of the vertical wheel seen, and turning air-tight through the packing or stuffing boxes, or in any other manner the external air is entirely excluded from the vertical wheel when at work; *e* is an airtight cock to discharge the air out of the machine when filling. *L* is an aperture into top reservoir, or into highest part of pipe *A*, *a* when no top reservoir, closed air-tight by a screw cap; by this the whole machine is filled in every part with the fluid used before it can be set to work, the bottom of pipe *A* and apertures *G* (as well as cock to bottom of pipe *E* when required) being previously closed. *P* is part of the axle on which the centrifugal wheel revolves. Before the machine can be put to work everything being previously arranged as directed, the apertures at *G* and bottom of *A* (and at *E* if required also), must be closed by sliding plates, valves, cocks, or other methods, as most convenient, and every part of the machine must be rilled with the water or fluid used by the aperture *L*, or any other convenient method by which the highest parts may be filled, the air allowed to discharge by opening *E* and *O*, the latter to be shut as soon as the centrifugal wheel is filled, and the cock at *E* closed where required, when the water is above it a

little, e continuing open so as to allow the air to be entirely discharged from every part, which being done, and the machine entirely filled with water, this cock and aperture L must be carefully closed; having then fixed upon the most convenient method for giving the required assistance to set the machine to work, by giving the centrifugal wheel motion, and assisting it till arrived at the velocity fixed, it must be put in motion and the apertures G opened; after it has got a little into motion, and as soon as the velocity of the wheel has given a centrifugal force to the water sufficient to overbalance the slight difference in the height of the feeding and descending columns, the pipe A must be opened; a discharge from the apertures G will now take place, which is supplied from top reservoir B over the loaded side of vertical wheel, where, by its gravity and impetus acting on the float boards, it causes the wheel to turn till it descends, so as to be discharged through E, on the rim or waterway W, of the centrifugal wheel, which it strikes with the velocity of its descent in nearly the direction of the wheel's motion, and is discharged through apertures G into the water contained at commencement in lower reservoir I, from whence this discharge is again supplied by the pressure of the atmosphere, returning it through pipe A into top reservoir, or through a, C, and the part intended of the vertical wheel. As the velocity of the centrifugal wheel is accelerated, the velocity of the descending column over the vertical wheel will also be accelerated, and, consequently, the vertical wheels, when having arrived at their respective fixed velocities, the assisting force being no longer necessary, may be withdrawn, and the centrifugal wheel may now receive what assistance is required to support its velocity from the vertical wheel through the connecting shafts and wheelwork, or in any other manner.

#### **Eaton's Perpetual Siphon. London. 1850**

The account of this is taken from Dircks's great work, mentioned in the preface, and is as follows:

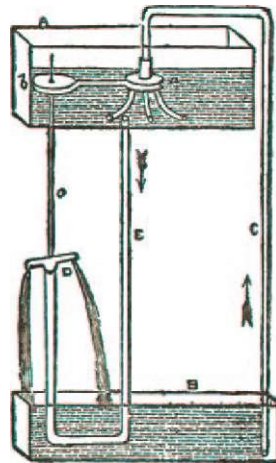

This is a plan proposed by Mr. Eaton in 1850, and consists in providing two water cisterns A, B; the short leg of a siphon C enters the upper cistern, and terminates in three escape pipes, capable of being rotated by the pulley a, connected by a band with the pulley b, affixed to the vertical shaft c, rotated by the inverted Barker's mill D, constructed on the short leg of the inverted siphon E, supplied from the bottom of the upper water cistern. By this means it was expected to keep up a continual flow down the pipes C and up E, as shown by the arrows.

### Legge's Hydro-Pneumatic Power Device. 1850

This is an English inventor claims that it is the years' study. We take the Dircks. It is as follows:

It is a dome-shaped vessel; its upper part is filled with air, and the lower half with water. This vessel contains two returning the water which is D, apparently like pump to be at from 250 to 500 the square inch.

When once started it will (it long as it is oiled. The in-one thirty-second share at pounds value.

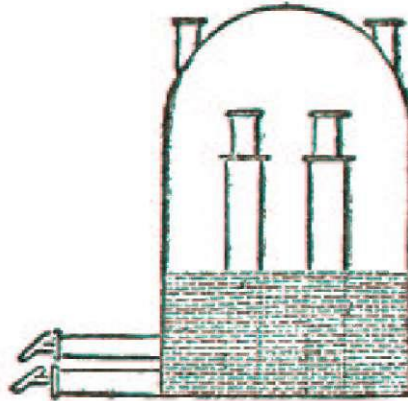

production, and the result of fourteen description from

upper part A filled with water, as at B. apparatus for worked through C barrels. The air is pounds pressure on

is stated) go on as inventor estimates a one thousand

### Waterblowing Machine

In 1827 "Mechanics' Magazine," London, published an account of an invention which was furnished to it by some correspondent. The invention, it seems from the communication, had previously been described in an appendix by Dr. Brewster to a volume of Ferguson's lectures, and it also seems that the description furnished "Mechanics' Magazine" was copied from such appendix. The following is the article as it appeared in "Mechanics' Magazine":

I am encouraged to send you the following attempt at perpetual motion, because I think it is upon a principle that has not yet been examined in your pages.

In Dr. Brewster's appendix to Ferguson's lectures, the following description is given of what is called a "Water Blowing Machine": "Let A B see Fig.) be a cistern of water, with the bottom of which is connected the bended leaden pipe B C H. The lower extremity H, of the pipe is inserted into the top of a cask or vessel, D E, called the condensing vessel, having the pedestal P fitted to its bottom, which is perforated with

two openings, M N. When the water which comes from the cistern A is falling through the part, C H of the pipe, it is supplied by the openings or tubes, *m n o p*, with a quantity of air which it carries along with it. This mixture of air and water, issuing from the aperture H, and impinging upon the surface of the stone pedestal P, is driven back and dispersed in various directions. The air being thus separated from the water, ascends into the upper part of the vessel, and rushes through the opening F, whence it is conveyed to the fire, while the water falls to the lower part of the vessel, and runs out by the openings M N." The author then goes on to describe the construction of the pipe B C H, in the curve of which some nicety is required, and to explain some atmospherical phenomena upon the principle of this machine, adding that "Franciscus Tertius de Lanis observes that he has seen a greater wind generated by a blowing machine of this kind than could be produced by bellows ten or twelve feet long."

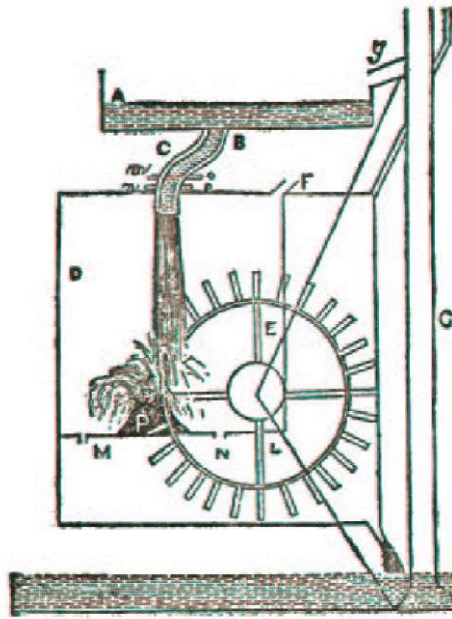

Now, if, instead of the pedestal P, a wheel were placed in the condensing vessel, as in the figure, would not the water, in falling upon the wheel, be sufficiently dispersed to disengage the air at the same time that it drove the wheel, and would not the motion of the wheel be retarded by the density of the internal air ?

I do not apprehend that any considerable resistance would be offered by the internal air, and the motion of the wheel can be regulated by its load, so as to offer a sufficient resistance to the descending stream of water; and I, therefore, assume that the water, in its descent, would produce by means of the wheel, a power capable of raising a part of the water expended back again to the cistern; and this is the extent of the power of most of those machines which have been mistaken for perpetual motions by their projectors. But I have a blast of wind which is described as being of great force. Can this blast be in any way applied to raise the surplus water ? I think I see the smile which the proposal will produce in those who deny the possibility of a perpetual motion. "A mere puff of wind!" is doubtless ejaculated from all sides. But let me tell these gentlemen that, though I may not know any method by which such blast can produce that effect, it does not, by any means, follow that the impossibility of the thing is thence to be presumed. Far from it; for such a conclusion rests upon the supposition that the powers and application of a blast of wind are fully known, and that no research or experience can add to our knowledge on that subject assumptions which appear to me somewhat ridiculous. Allow me, for the sake of argument, to suppose that this blast instead of wind, had been a blast of steam. Time was when wise men would have smiled and

said, "A puff of steam a mere puff of steam !" and had some one, more sanguine than the rest, attempted by its application to produce a motion, he would have applied it to the floatboards of a wheel, as in Branca's engine, and have been disappointed. It is not given to man to know when the powers of any great agent have been fully developed; and those who act upon such presumptions throw the greatest obstacles in the way of inquiry. But, to show the anti-perpetualists that within their own time since the commencement of the "Mechanics' Magazine," an addition has been made to our knowledge of the powers of a blast of wind, I have added a tube, G, to my figure, the proposed use of which I shall now describe.

In a part of the "Mechanics' Magazine," published some time ago, there was described a novel mode of raising water in a tube by directing a stream of air over its mouth, thereby destroying the pressure of the atmosphere.

I do not suppose it will rise to the height of the cistern as I have figured it; but it may still be a question whether it may not be accomplished by a series of short tubes, the bottom of the one being placed in the cistern into which the next below discharges its water, each being con

structed with a blast and two valves, in the same manner as the single tube namely, the valves *x* (under water) and *y*, worked in such a manner by the arms *K L*, that the one may shut when the other opens. Presuming that the water will rise to the top of the tube when the blast is in action (*x* open and *y* shut), the water in the part of the tube between the blast and *y* will be discharged into the cistern at the next motion of the valves namely, when *x* is shut and *y* opened, the blast, at the same time, being discontinued.

### Device by Means of Buoyancy Through Media of Different Densities

An account of this appeared in "Mechanics' Magazine," 1825. The author apparently had no great faith in the Perpetual Motion, and yet it is manifest abandoned hope of accomplishing it, along some line of attaining it. It goes the device failed. The account however, is as follows:

The unsuccessful (but far from fruitless) "philosopher's stone," and the "elixir important and beneficial results in the parity of consequence, I am disposed to the "perpetual motion" (though equally will result to the mechanical world. \* \* I device. The point at which, like all the (as I do now) plainly perceive at once, obvious. The original idea was this to float in a heavy medium and

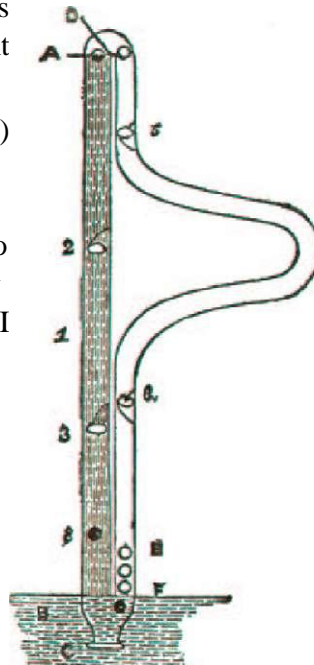

accomplishment of that he had not and is still thinking without saying that furnished,

search made to discover the "vite," were productive of most kingdom of chemistry; so, by a believe that from inquiry after unsuccessful), a similar good beg leave to offer the prefixed rest, it fails, I confess I did not although it is certainly very enable a body which would

sink in a lighter one, to pass successively through the one to the other, the continuation of which would be the end in view. To say that valves cannot be made to act as proposed will not be to show the *rationale* (if I may so say) upon which the idea is fallacious.

The figure is supposed to be tubular, and made of glass, for the purpose of seeing the action of the balls inside, which float or fall as they travel from air through water and from water through air. The foot is supposed to be placed in water, but it would answer the same purpose if the bottom were closed.

DESCRIPTION OF THE ENGRAVING.—No. 1, the left leg, filled with water from B to A. 2 and 3, valves, having in their centers very small projecting valves; they all open upwards. 4, the right leg,\* containing air from A to F. 5 and 6, valves, having very small ones in their centers; they all open downwards. The whole apparatus supposed to be air- and water-tight. The round figures represent hollow balls, which will sink one-fourth of their bulk in water (of course will fall in air); the weight, therefore, of three balls resting upon one ball in water, as at E, will just bring this top even with the water's edge; the weight of four balls will sink it under the surface until the ball immediately over it is one-fourth its bulk in water, when the under ball will escape round the corner at C, and begin to ascend.

The machine is supposed (in the figure) to be in action, and No. 8 (one of the balls) to have just escaped round the corner at C, and to be, by its buoyancy, rising up to valve No. 3, striking first the small projecting valve in the center, which, when opened, the large one will be raised by the buoyancy of the ball; because the moment the small valve in the center is opened (although only the size of a pin's head), No. 2 valve will have taken upon itself to sustain the whole column of water from A to B. The said ball (No. 8) having passed through the valve No. 3, will, by appropriate weights or springs, close; the ball will proceed upwards to the next valve (No. 2), and perform the same operation there. Having arrived at A, it will float upon the surface threefourths of its bulk out of water. Upon another ball in due course arriving under it, it will be lifted quite out of the water and fall over the point D, pass into the right leg (containing air), and fall to valve No. 5, strike and open the small valve in its center, then open the large one and pass through; this valve will then, by appropriate weights or springs, close, the ball will roll on through the bent tube (which is made in that form to gain time as well as to exhibit motion) to the next valve (No. 6), where it will perform

the same operation, and then, falling upon the four balls at E, force the bottom one round the corner at C. This ball will proceed as did No. 8, and the rest in the same manner successively.

**Device by Compressible and Distensible Bags in Liquid**

In the year 1823, an account of a Perpetual Motion device was sent to "Mechanics' Magazine" by some correspondent. This appears to have considerable claim to ingenuity, though the correspondent states that "it failed from friction." The figure and account furnished are as follows:

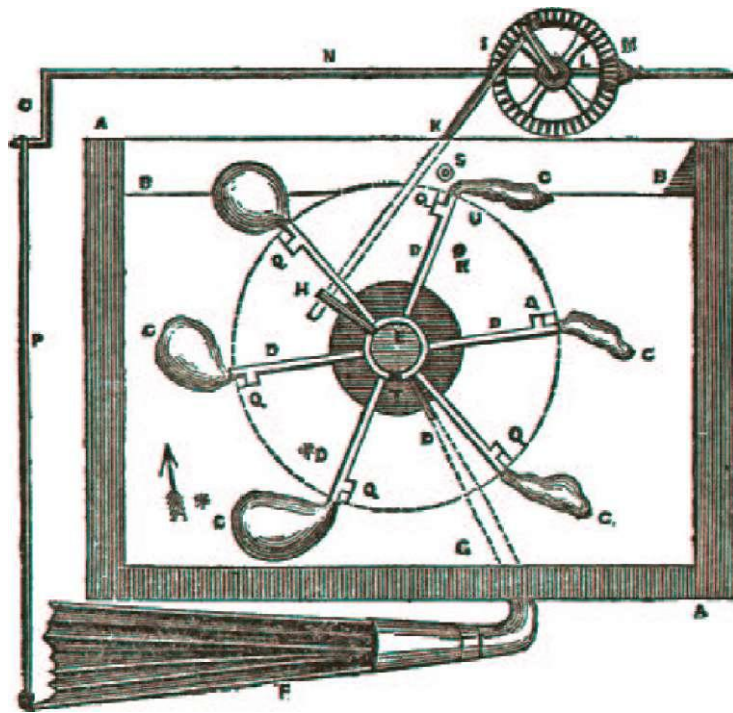

A A A A is a cistern of water, filled as high as BB. CCCCCC are six bladders, communicating by the tubes D D D D D D with the hollow axle E, which axle is connected with the bellows F by the pipe G. H is a crank connected with the crank I by the rod K. L is a saucer-wheel, M a pinion, N its shaft. O is a crank attached to the bellows F by the rod P. Q Q Q Q Q Q are valves with a projecting lever. R and S are two projecting knobs. T is a hole in the axle E, forming a communication with it and the lowermost bladder. The axle B being put in motion carried round the bladders and tables, and by the cranks H and I, and the connecting-rod K, caused the wheel L to revolve, which communicating a similar but

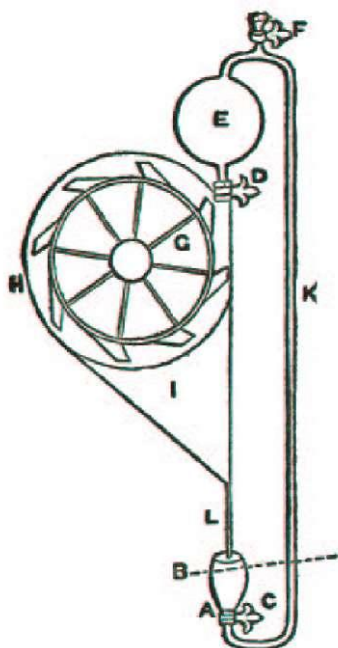

or blew the bellows F by the rod tube G, and passing through the bladder C by the tube D; this lighter than the space it occupied, behind it over the hole in the axle thereby gained an ascending motion on the one behind it. When one of the lever of the valve Q struck when the bladder arrived at U and the water drove out the air and knob R then closed the valve Q water into the bladder; by this

contrivance three of the bladders were full and empty, according as they passed over the hole T or the knob S.

**George Cunningham's Mercurial Pneumatic Device. Ireland. 1729**

Among the papers in the British Museum is one which purports to relate to the Royal Society, and in that Royal Society volume it is number 32. It is quite amusing. The author explains that he is withholding many precise details and measurements "such as workmen should follow in making the engine. Intending no more here than the endeavor to satisfy some others as well as myself, that there is really such a thing to be found as that long-sought for Perpetual Motion, which is looked upon by every one to be the true parent of the Longitude.— Description of the Perpetual Motion":

A, a cup nearly full of mercury.

B, the height the mercury will rise by its own weight in— K, the main pipe,  
when—

C, the lower cock is open.

E, a hollow globe which must be capable of a greater quantity than the whole pipe K.

F, the upper cock by which the mercury is filled into the engine and about 27 inches higher than the line B.

D, the middle cock which, when open, lets the mercury fall upon the buckets of the wheel—

G, and then passing down—

I, a funnel which contracts itself at

L, into a pipe which directs the mercury into the cup A.

H, a case which entirely covers the wheel (being of the same metal, and of a piece with the pipe), through which the axis of the wheel passes to set another wheel agoing; so becom [ing] the principal mover in the clock or engine to be contrived.

#### *The Manner of Setting It to Work*

Stop the cock at C and fill mercury into the cup A, higher than the line B; then stop the cock at D and turn in mercury at the cock F, till K and E are full; stop the cock at F, very close, open C, first, and then D, out of which the mercury will fall upon the buckets of the wheel G, down the funnel I, L, into the cup A, and be pressed up K, by the weight of the air, as in the barometer.

#### **Why the Devices Described in this Chapter Failed to Work**

The devices explained in the preceding chapter are of such complicated and ridiculous structure that it is impossible to explain anything from them. It is better to abandon them all and to discuss in a general way why Perpetual Motion has not been, and cannot be, attained by devices constructed on similar plans. An examination of the preceding devices in this chapter shows that they depended ultimately upon the fact:

1. That air or some other gas is to be compressed by work done upon it and that upon expanding it will do a greater amount of work than was required for the compression, or
2. That a bag empty, or partially filled with air, or other gas, can be easily immersed, and that if blown full of gas while immersed it will, in its tendency to float, do more work than was required to immerse it, or
3. That the weight of the atmosphere and its consequent pressure upon vacua can be utilized to drive a piston, or compress a bag and by some sort of means at the same time produce another vacua ready for a similar operation, the loss of the driven piston, or the compressed bag being utilized to drive machinery, if desired.

It is now believed by all scientific men that none of these things are possible. In the first place, it is well known that compressed air will do exactly the same work in regaining its former volume that was expended upon it to compress it, and this with absolute exactness. In compressing the gas with a piston the force exerted upon the rod to drive the piston must be sufficient not only to compress the gas but also to overcome the friction of the tight fitting piston, and further, if the pressure on the

rod be removed, the expanding gas will deliver against the face of the piston exactly the force and energy required to drive the piston for the compression, but not all of this can be returned to any machinery driven by the piston-rod, for a part will be lost in the friction of the tight-fitting parts. Thus here, as elsewhere, there is an exact equivalent of energy a part of which is consumed in friction, and only a part available for returned motion. The same thing is true in compressing a bag, except that possibly the bending of the fabric is less resistance than the friction of the tight-fitting piston. Still, the bending of the fabric is some resistance, and consequently the bag so expanding cannot return all the energy required for its compression, the difference being the loss, however slight, in the bending of the fabric of which the bag is made.

Again, let us admit that a dilated bag is easily immersed in water, and that if inflated with air there will be considerable tendency to rise, but how much energy is required for the inflation? It is manifest that if it is immersed the weight of the water and its consequent pressure will resist the attempted inflation, and must be overcome before the inflation is complete. The deeper the immersion the more the compression, and consequently the more work required for the inflation. If a bag having a contents of one cubic foot were immersed a mile in fresh water, and if it should be attempted to inflate it, the reader will perhaps be surprised to know that the inflation would have to be done against a pressure of substantially 2,400 pounds to the square inch. It is simple that the deeper the bag is immersed the more work it will do in rising to the surface, but it is equally plain that the deeper it is immersed the more energy is required for its inflation. In each case the work of inflating is exactly equal to the work returned in rising to the surface, and there is not one whit to spare for running machinery of any kind.

The third classes of devices above mentioned assume atmospheric pressure, and a piston driven by atmospheric pressure. This is easily attained, but in order for atmospheric pressure to drive a piston it must only be on one side of the piston, and when the piston has been driven what force and energy will be required to put it in a position again such that there will be atmosphere on only one side, and a vacuum into which it can retire, on the other side? It is easily answered. The same work must be done, and the same work exactly, to put the piston again in the position with the vacuum with equal dimensions into which it can be driven by atmospheric pressure, that first drove it to occupy the vacuum exactly the same work, and no less and no more, except that the amount lost by friction must be supplied in addition.

## Chapter V

### MAGNETIC DEVICES

#### A Magnetic Pendulum

Here we present a device for Perpetual Motion by magnetism, but we are unable to give the inventor's name or his nativity. It seems to have been brought forth in the early part of the nineteenth century, prior to 1828. The description is as follows:

*o*/*o*

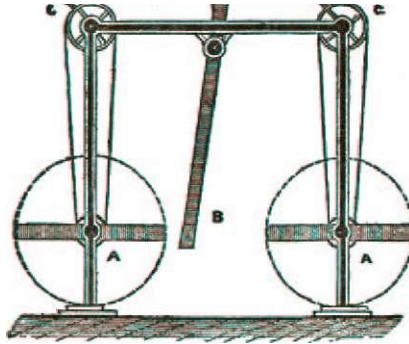

Let A A, in the prefixed engraving, represent two magnets revolving on axes. Let B represent a larger magnet, hanging on an axis, pendulum fashion, between the two former. As the poles of the two smaller magnets lie in the same direction, the effect will be to draw the larger magnet towards that on the left hand, while it is at the same time repelled by that on the right; but while this is going on, the upper end of

the large magnet raises by means of a guide wire, the tumbler D, which, just before the magnets come in contact, passes the perpendicular and falls over, carrying with it the lever connected with the two wheels C C, and causing them to perform a quarter revolution ; these wheels are connected by lines with two small wheels fixed on the axles of the two magnets A A. While the former make a quarter revolution, the latter turn half round; consequently, the position of the magnets is reversed, and the same motions are then performed by the pendulum magnet being attracted and repelled in the opposite direction; and just before the magnets touch each other the arrangement is again instantly reversed.

### Magnetic-Driven Wheel

Another plan for Perpetual Motion by magnetism appeared in the public journals of England in 1828. The inventor states in effect that he desires to get before the readers an "Attempt at Perpetual Motion by Means of Magnetism, Applied in a New Way."

His attempt as published is as follows:

The object of the present communication is to lay before your readers an attempt at perpetual motion by means of magnetism applied somewhat differently to any that has yet been published in your Magazine.

The above is a wheel of light construction, moving on friction wheels *in vacuo*; the rim is furnished with slips of steel pieces of magnets, which, attracting the rim of lighter and the other heavier, causing it to revolve *ad infinitum*: or to render it more powerful, let the steel the wheel with their north poles magnets be added, as shown by the placed with their south poles nearest

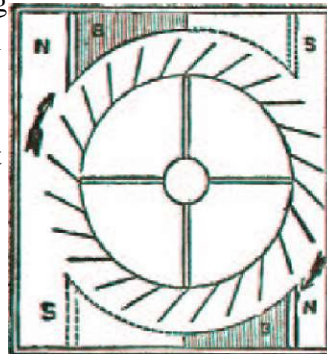

watchspring will do. N N are two the wheel, will render one side it to revolve *ad infinitum*: or to rims be magnetized and fixed on towards its center. Let two more dotted lines: let these two, S S, be the rim of the wheel; and the other

two, N N, with their north poles in that position. Now, as similar poles repel and opposite poles attract, the wheel will be driven round by attraction and repulsion acting conjointly on four points of its circumference. B B are blocks of wood to keep off the attraction of the magnets from that part of the wheel which has passed them.

### Mackintosh's Experiment

F. S. Mackintosh, of England, in 1823, sought to accomplish Perpetual Motion, and made the attempt here described. It was not made public until 1836, when it was published in "Mechanics' Magazine." In the meantime, the inventor had become convinced of the impossibility of perpetual motion, as his comments on his own alleged invention discloses.

(The classification in this book of Mackintosh's invention is somewhat doubtful. The article as contributed in 1836 would as aptly be classified under arguments against Perpetual Motion, Chapter XII. But, in view of the fact that at the time of the invention the inventor was seriously working at a scheme for the accomplishment of Perpetual Motion, it has been decided to classify it under Magnetic Perpetual Motion Devices.)

The published article was in the nature of a contribution from the inventor, and is as follows:

I herewith forward you a description of a machine which was constructed by me in the year 1823, with a view to produce a perpetual motion. With this machine and the studies necessarily connected with it, first originated the suspicion that the planets could not continue in motion unless they gradually approached the center of the attraction.

In the first place, let us describe the machine. Fig. 1: A is a sectional view of the interior of the wheel, which is formed in two halves upon one shaft; each half or section is furnished with a projecting ledge and an opening is left between the two ledges sufficiently wide to admit of a magnet being introduced between them, by which arrangement the magnet may be brought as near to the ball as may be necessary (see Fig. 2). B is a magnet whose line of attraction acts at right angles with the line of gravity. C is an iron ball under the action of two forces. The magnet continually drawing the ball up the inclined plane within the wheel, and gravity continually drawing it to the bottom, by their united action it was supposed the wheel would revolve forever, or till it was worn out; upon the same principle that a wheel revolves by the animal force or muscular action of a mouse or squirrel, which carries it up the inclined plane, whilst it is continually drawn to the bottom by the action of gravity, thereby causing the wheel to revolve by the weight of its body. The model was taken from the earth's motion round the sun; and the following process of reasoning seemed to justify the assumption that the wheel would move on till it was worn out:

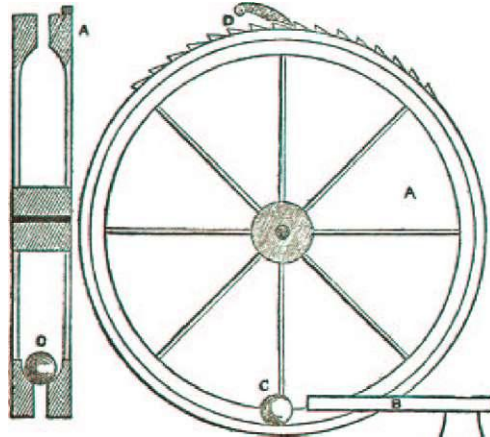

"The earth is carried round the sun by the action of two forces, one of which is momentum, which is not, in reality, a force or cause of motion, but an effect derived from an original impulse ; and that impulse or the momentum derived from it is not destroyed, because there is no resistance to the moving body—that is, there is no friction. Well, I cannot make this machine without having resistance to the motion that is, friction ; but to compensate for this I have two real forces, two causes of motion, each of them capable of imparting momentum to a body: they are both constant forces; and from one of them, the magnet, I can obtain any power that may be required within certain limits."

This reasoning appeared conclusive, and the wheel was made; but when the magnet was applied instead of the ball rolling up the inclined plane, the wheel moved backwards upon its center. It occurred to me that by placing a small ratchet upon the wheel, as shown at D, this backward motion of the wheel on its center might be prevented, in which case the ball must roll up the inclined plane, and that a perpetual motion might then ensue; but this ratchet I never tried, having about that time begun to perceive that the idea of a perpetual mechanical motion, either on the

earth or in the heavens, involves an absurdity; and that, therefore, the motions of the planets must necessarily carry them continually nearer and nearer to the center of attraction.

The above described device by Mr. Mackintosh brought forth the following comment from R. Munro, which was published in 1836:

The result of Mr. Mackintosh's essay at perpetual motion might be attributed to the avoidable friction caused by the manner in which the iron ball is placed in the wheel. Curious to try the experiment, I proceeded, and, with the view of diminishing the friction, I placed two wheels on the axis of the ball, but the result was precisely that described by Mr. Mackintosh. I next applied the ratchet, as suggested, but with no better effect; the ball rolled towards the magnet, but did not give the required motion to the wheel. It is not unlikely, then, that the present ingenious attempt will not be realized.

### Spence's Device

John Spence, of Linlithgow, Scotland, was a shoemaker, but possessed great mechanical ingenuity. He could not keep his mind from the subject of mechanics. He devoted a great deal of time to designing mechanical schemes for Perpetual Motion. An account of his efforts is taken from "Percy Anecdotes."

The device was exhibited in Edinburgh and amazing to state it attracted the attention of one of the greatest and most original scientists that ever lived, Sir David Brewster.

It is from a letter written by Brewster, in 1818, to the

"Annales de Chimie," that

we get

a description of the Spence in-  
 of "Annales de Chimie," was  
 to publish any article  
 Perpetual Motion, and only the  
 fame of Sir David induced  
 him to give space to the  
 article was first published in  
 with an introductory statement  
 translated into English, as follows:

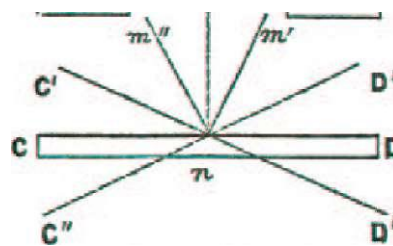

vention. The editor  
 evidently reluctant  
 concerning  
 great

contribution. The  
 France, but it has,  
 by the editor, been

The reader will readily conclude that in publishing this article we are influenced solely by the great reputation of the learned contributor. Sir David writes from Edinburgh:

I am almost afraid to inform you that at this moment in Edinburgh may be seen a machine, made by a shoemaker at Linlithgow, which realizes the perpetual motion. This effect is produced by two magnets A and B, acting alternately upon a needle *m n*, of which the point of attachment *n* corresponds around which turns the movable lever C D. When attracted into the position *m' n* by the action of the consequence found in C D', a substance interposed by mechanism between *m' n* and B. This substance has the property of intercepting, or rather of modifying the action of the magnet B, and this permits the other magnet A to draw the needle into the position *m' n*; but no sooner has it reached this point than a second plate or layer of the same substance places itself before magnet, and immediately B attracts anew the needle.

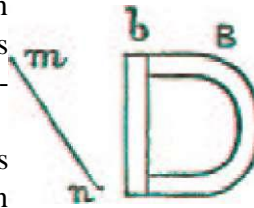

exactly with the axis the needle *m n* has been magnet B, and C D is in connected with *m n* is This substance has the

The annexed figure exhibits a second form of the machine. A and B are two horse-shoe magnets, *a* and *b* the *mysterious substance*, and *m n* the needle, which turns constantly with great rapidity. Mr. Playfair and Capt. Kater have inspected both of these machines, and are satisfied that they resolve the problem of *perpetual motion*.

### Joannis Theisneri's Semi-Circle

An account of this invention has been preserved by Caspar Schott in a work entitled "Thaumaturgus Physicus, sive Naturae et Artis," published in 1859. It following figure:

FIC. S.



Magiae Universalis is illustrated by the

The inventor expected the operation of his device to be as follows: "A" is a large magnet, elevated on a short pillar at the foot of which is a straight inclined tube, "C" "F" the ends of which are connected with a curved or semi-circular tube "C", "D", "E", "F", as shown in the figure.

The weight at the lower extremity is supposed to ascend through the curved tube by the attraction of the magnet "A" and upon reaching the point "C" the supposition was that upon passing the point "C" the attraction of the magnet "A" would be sufficient to hold it there \* \* \* back to the point "F" through the straight tube, and then be drawn by the magnet through the curved tube to the point "C" and so on perpetually.

The impracticability of the above device is manifest. At a point between "D" and "E" it is plain the ball would have to ascend perpendicularly and if the magnet exerts sufficient attraction to elevate the weight at that point it would surely hold the weight at the point "C", for at "C" the weight would be much nearer the magnet and consequently much more strongly attracted.

### Device of Dr. Jacobus

In the same work by Caspar Schott from which an account of the preceding device is obtained he gives an account of the device of Dr. Jacobus.

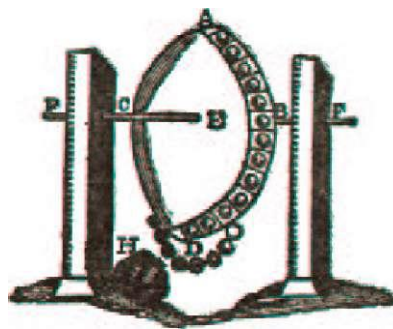

Dr. Jacobus's scheme is illustrated by the following figure:

It will be observed that the above figure shows a string of iron balls "A" suspended on a grooved wheel "E" on an axle "C" between two uprights

"FF". At "H" lies a large lodestone, which is to attract the balls at "D" and was expected by the inventor to cause the wheel to rotate.

# Chapter VI

## Devices Utilizing Capillary Attraction and Physical Affinity

### Ludeke and Wilckens's Device

In 1864, Johann Ernst Friedrich Ludeke, of London, and Daniel Wilckens, of Surrey, applied for British patent on "Improvements in Motive Power by Capillary Attraction." They describe their invention as follows:

Our invention consists of improvements in motive power by capillary attraction constructed as follows:

Figure 1 of the accompanying drawings represents in horizontal section a square case or cistern; this cistern is filled with water nearly to the top, and two wheels marked *a, a*, and *b, b*, are placed in the water in the cistern. By capillary attraction the water rises between the two wheels marked *x, x*, to a height above the level of the water in proportion to the distance of the wheels from each other at *x, x*. As the water rises between the wheels marked *x, x*, above its level, the weight of water between the wheels at *x, x*, will cause the wheels to continually revolve.

Figure 2 represents the same, as Figure 1, but in a vertical section. The said power may be obtained by wheels moved on axis, or by other apparatus by rise and fall in the water by vertical motion.

### The Jurin Device

The device which we have designated "The Jurin Device," was not, in fact, invented by Jurin. James Jurin furnished an account of the invention to The Royal Society of London, and it appears in the reports of that society published in 1720. The invention was by a friend of Jurin's whose name he does not give in the account. Jurin's account of his friend's invention is as follows:

Some days ago a method was proposed to me by an ingenious friend for making a perpetual motion, which seemed so plausible, and indeed so easily demonstrable from an observation of the late Mr. Hawksbee, said to be grounded upon experiment, that though I am far from having any opinion of attempts of this nature, yet, I confess, I could not see why it should not succeed. Upon trial indeed I found myself disappointed. But as searches after things impossible in themselves are frequently observed to produce other discoveries, unexpected by the Inventor; so this Proposal has given occasion not only to rectify some mistakes into which we had been led, by that ingenious and

useful member of the Royal Society above named, but likewise to detect the real principle, by which water is raised and suspended in capillary tubes, above the level.

My friend's proposal was as follows:

Fig. 1. Let A B C be a capillary siphon, composed of two legs A B, B C, unequal both in length and diameter; whose longer and narrower leg A B having its orifice A immersed in water, the water will rise above the level, till it fills the whole tube A B, and will then continue suspended. If the wider and shorter leg B C, be in like manner immersed, the water will only rise to same height as F C, less than the entire height of the tube B C.

This siphon being filled with water and the orifice A sunk below the surface of the water D E, my friend reasons thus:

Since the two columns of water A B and F C, by the supposition, will be suspended by some power acting within the tubes they are contained in, they cannot determine the water to move one way, or the other. But the column B F, having nothing to support it, must descend, and cause the water to run out at C. Then the pressure of the atmosphere driving the water upward through the orifice A, to supply the vacuity, which would otherwise be left in the upper part of the tube B Cs this must necessarily produce a perpetual motion, since the water runs into the same vessel, out of which it rises. But the fallacy of this reasoning appears upon making the experiment.

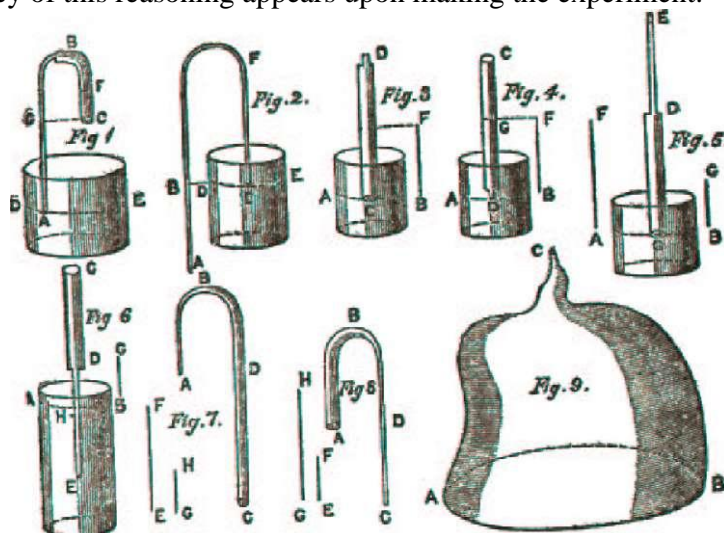

Exp. 1. For the water, instead of running out at the orifice C rises upwards towards F, and running all out of the leg B C, remains suspended in the other leg to the height A B.

Exp. 2. The same thing succeeds upon taking the siphon out of the water, into which its lower orifice A had been immersed, the water then falling in drops out of the orifice A, and standing at last at the height A B. But in making these two experiments it is necessary that A G the difference of the legs exceed F C, otherwise the water will not run either way.

Exp. 3. Upon inverting the siphon full of water, it continues without motion either way. The reason of all which will plainly appear, when we come to discover the principle, by which the water is suspended in capillary tubes.

Mr. Hawksbee's observation is as follows:

Fig. 2. Let A B F C be a capillary siphon, into which the water will rise above the level to the height C F, and let B A be the depth of the orifice of its longer leg below the surface of the water D E. Then the siphon being filled with water, if B A be not greater than C F, the water will not run out at A, but will remain suspended.

This seems indeed very plausible at first sight. For since the column of water F C will be suspended by some power within the tube, why should not the column B A, being equal to, or less than the former, continue suspended by the same power.

Exp. 4. In fact, if the orifice C be lifted up out of the water D E, the water in the tube will continue suspended, unless B A exceed F C.

Exp. 5. But when C is never so little immersed in the water immediately the water in the tube runs out in drops at the orifice A, though the length A B be considerably less than the height C F.

Mr. Hawksbee, in his book of Experiments, has advanced another observation, namely, that the shorter leg of a capillary siphon, as A B F C, must be immersed in the water to the depth F C, which is equal to the height of the column, that would be suspended in it, before the water will run out of the longer leg.

Exp. 6. From what mistake this has proceeded, I cannot- imagine; for the water runs out at the longer leg, as soon as the orifice of the shorter leg comes to touch the surface of the stagnant water, without being at all immersed therein.

Jurin's attitude concerning his friend's discovery is pleasing. He appears to have had better judgment than to rush into print, or herald forth that Perpetual Motion had been accomplished. Indeed, the account as given to the Royal Society was that of an experiment and a failure. Nevertheless, it presents an interesting point. Capillary Attraction, however, creates no new energy. Adhesion is a force, and is often quite a strong force in nature.

If a rod or tube be held by the hand at one end, and the other end inserted in a liquid, it will be observed that in some instances, depending upon the nature of the material of the rod or tube, and the liquid, at the point of contact the liquid will slightly rise in the tube and on the outside edges of the tube. In other instances it will be depressed slightly at the same point. Whether it will be elevated or depressed depends on whether the adhesion of the liquid to the material of which the tube or rod is composed is greater than the cohesion of the particles of the liquid.

If there be a depression it is manifest that the entire surface of the liquid will be slightly elevated by reason of the depression. On the contrary, if the liquid adheres to and creeps slightly upward on the tube or rod, then it is manifest that the surface of the liquid will come to rest slightly lower than though it did not so creep.

The net result finally gets back to the principle of flotation. The immersion or insertion is a little more difficult in the case of depression, and a little easier in the case of elevation. There is no gain or loss of energy. It simply increases in one case, and diminishes in the other case the amount of displacement, with all the resulting mechanical phenomena.

### **Sir William Congreve**

As stated in the preface of this work, pursuit of Perpetual Motion has by no means been confined to mechanics and tradesmen. Many men eminent, and even famous in professions, art and science have devoted much time and thought to the subject. Among such eminent men is to be mentioned Sir William Congreve, of England, a baronet. He was born 1772, and died in 1828. He was an artilleryman and an inventor, and was a son of Lieutenant General Sir William Congreve; was distinguished as a military man, as a member of parliament, and as a business man; was an inventor of note, having invented a war rocket, a gun-recoil mounting, a time-fuse, a parachute attachment for rockets, a hydro-pneumatic canal lock sluice, a process for color painting, a new form of steam engine, a method of consuming smoke, a clock which measured time by a ball rolling down an

inclined plane, besides other inventions and discoveries. He published a large number of works on scientific subjects.

It is not, therefore, surprising that whatever Sir William Congreve said or did concerning any scientific or mechanical subject should have attracted general attention.

He devised and made a Perpetual Motion Machine, which, like all others, failed to work. We submit that his plan is peculiarly ingenious, and we fail to see how, without a knowledge of the principles of Conservation of Energy, the Congreve idea should not have appealed to any one as reasonable, and its failure puzzling.

An account of the Congreve device and an explanation of his ideas appeared in "The Atlas"\* in 1827, and the following description is taken from the article appearing in "The Atlas":

The celebrated Boyle entertained an idea that perpetual motion might be obtained by means of capillary attraction; and, indeed, there seems but little doubt that nature has employed this force in many instances to produce this effect.

There are many situations in which there is every reason to believe that the sources of springs on the tops and sides of mountains depend on the accumulation of water created at certain elevations by the operation of capillary attraction, acting in large masses of porous material, or through laminated substances. These masses being saturated, in process of time become the sources of springs and the heads of rivers; and thus, by an endless round of ascending and descending waters, form, on the great scale of nature, an incessant cause of perpetual motion, in the purest acceptance of the term, and precisely on the principle that was contemplated by Boyle. It is probable, however, that any imitation of this process on the limited scale practicable by human art would not be of sufficient magnitude to be effective. Nature, by the immensity of her operations, is able to allow for a slowness of process which would baffle the attempts of man in any direct and simple imitation of her works. Working, therefore, upon the same causes, he finds himself obliged to take a more complicated mode to produce the same effect.

To amuse the hours of a from illness, Sir William recently contrived a scheme motion, founded on this capillary attraction, which, will not be subject to the applicable to those plans in supposed to be derived Sir William's perpetual follows:

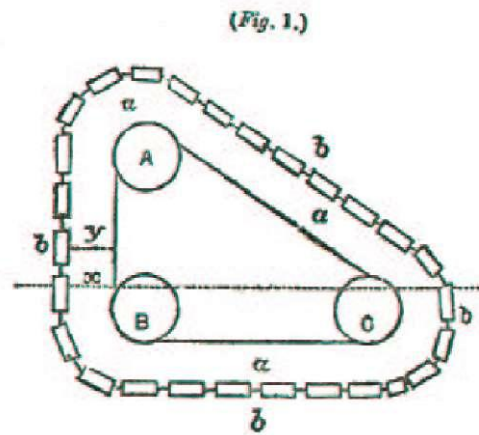

long confinement Congreve has re- of perpetual principle of it is apprehended, general refutation which the power is from gravity only. motion is as

Let  $A B C$  be three horizontal rollers fixed in a frame;  $a a a$ , etc., is an endless band of sponge, running round these rollers; and  $b b b$ , etc., is an endless chain of weights, surrounding the band of sponge, and attached to it, so that they must move together; every part of this band and chain being so accurately uniform in weight that the perpendicular side  $A B$  will, in all positions of the band and chain, be in equilibrium with the hypotenuse  $A C$ , on the principle of the inclined plane. Now, if the frame in which these rollers are fixed be placed in a cistern of water, having its lower part immersed therein, so that the water's edge cuts the upper part of the rollers  $B C$ , then, if the weight and quantity of the endless chain be duly proportioned to the thickness and breadth of the band of sponge, the band and chain will, on the water in the cistern being brought to the proper level, begin to move round the rollers in the direction  $A B$ , by the force of capillary attraction, and will continue so to move. The process is as follows:

On the side  $A B$  of the triangle, the weights  $b b b$ , etc., hanging perpendicularly alongside the band of sponge, the band is not compressed by them, and its pores being left open, the water at the point  $x$ , at which the band meets its surface, will rise to a certain height,  $y$ , above its level, and thereby create a load, which load will not exist on the ascending side  $C A$ , because on this side the chain of weights compresses the band at the water's edge, and squeezes out any water that may have previously accumulated in it; so that the band rises in a dry state, the weight of the chain having been so proportioned to the breadth and thickness of the band as to be sufficient to produce this effect. The load, therefore, on the descending side  $A B$ , not being opposed by any similar load on the ascending side, and the equilibrium of the other parts not being disturbed by the alternate expansion and compression of the sponge, the band will begin to move in the direction  $A B$ ; and as it moves downwards, the accumulation of water will continue to rise, and thereby carry on a constant motion, provided the load at  $x y$  be sufficient to overcome the friction on the rollers  $ABC$ . Now, to ascertain the quantity of this load in any particular machine, it must be stated that it is found by experiment that the water will rise in a fine sponge about an inch above its level; if, therefore, the band and sponge be one foot thick and six feet broad, the area of its horizontal section in contact with the water would be 864 square inches, and the weight of the accumulation of water raised by the capillary attraction being one inch rise upon 864 square inches, would be 30 lbs., which, it

is conceived, would be much more than equivalent to the friction of the rollers.

The deniers of this proposition, on the first view of the subject, will say, it is true the accumulation of the weight on the descending' side thus occasioned by the capillary attraction would produce a perpetual motion, if there were not as much power lost on the ascending side by the change of position of the weights, in pressing the water out of the sponge.

The point now to be established is, that the change in the position of the weights will not cause any loss of power. For this purpose, we must refer to the following diagram.

With reference to this diagram, suppose *a a a*, etc., an endless strap, and *b b b*, etc., an endless chain running round the having any sponge kept at a certain distance small and inflexible props, sides A B and C A would, system, be precisely an require only a small incre- either side to produce contend that this still remain unaffected, if introduced in lieu of the *p*, so that the chain *b b b*

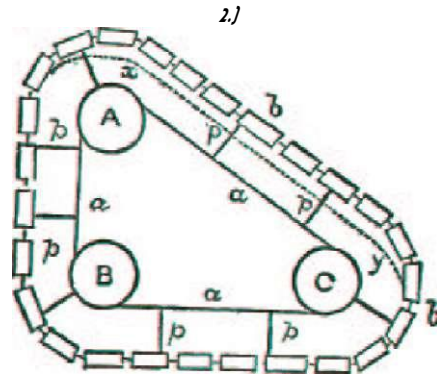

I

lower strap *a a a*, by compressing these small although the centre of gravity of any portion of case—for instance, in the dotted line—still the strap and chain would remain precisely the same in the former case, where they are kept at the same distance in all positions, as in the latter case, where they approach on the ascending side; and so, also, these equal portions of weights, notwithstanding any change of distance between their several parts which may take place in one case and not in the other, would in both cases rise and fall, though the same perpendicular space,

rollers; ABC not between them, but from each other by *p p p*, etc., then the in all positions of this equilibrium, so as to ment of weight on motion. Now, we equilibrium would small springs were inflexible props *p p* might approach the

springs with its weight on the ascending side; for chain would move in a different line in the latter quantity of the actual weight of every inch of the although the centre of gravity of any portion of case—for instance, in the dotted line—still the strap and chain would remain precisely the same in the former case, where they are kept at the same distance in all positions, as in the latter case, where they approach on the ascending side; and so, also, these equal portions of weights, notwithstanding any change of distance between their several parts which may take place in one case and not in the other, would in both cases rise and fall, though the same perpendicular space,

and consequently the equilibrium, would be equally preserved in both cases, though in the first case they may rise and fall through rather more than in the second. The application of this demonstration to the machine described in Fig. 1, is obvious; for the compression of the sponge by the sinking of the weights on the ascending side, in pressing out the water, produces precisely the same effect as to the position and ascent of the weights, as the approach of the chain to the lower strap on the ascending side, in Fig. 2, by the compression of the springs; and consequently, if the equilibrium is not affected in one case—that is, in Fig. 2, as above demonstrated it will not be affected in the other case, Fig. 1; and, therefore, the water would be squeezed out by the pressure of the chain without any loss of power. The quantity of weight necessary for squeezing dry any given quantity of sponge must be ascertained and duly apportioned by experiment. It is obvious, however, that whether one cubic inch of sponge required one, two, or four ounces for this purpose, it would not affect the equilibrium, since, whatever were the proportion on the ascending side, precisely the same would the proportion be on the descending side.

This principle is capable of application in various ways, and with a variety of materials. It may be produced by a single roller or wheel. Mercury may also be substituted for water, by using a series of metallic plates instead of sponges; and, as the mercury will be found to rise to a much greater height between these plates, than water will do in a sponge, it will be found that the power to be obtained by the latter materials will be from 70 to 80 times as great as by the use of water. Thus, a machine, of the same dimensions as given above, would have a constant power of 2,000 lbs. acting upon it.

We now proceed to show how the principle of perpetual motion proposed by Sir William Congreve may be applied upon one centre instead of three.

In the following figure, *a b c d* represents a drum-wheel or cylinder, moving on a horizontal axis surrounded with a band of sponge 1 2 3 4 5 6 7 8, and immersed in water, so that the surface of the water touches the lower end of the cylinder. Now then, if, as in Fig. 2, the water on the descending side *b* be allowed to accumulate in the sponge at *x*, while, on the ascending side *D*, the sponge at the water's edge shall, by any means not deranging the equilibrium, be so compressed that it shall quit the water in a dry state, the accumulation of water above its level at *x*, by the capillary attraction, will be a source of constant rotary motion;

and, in the present case, it will be found that the means of compressing the sponge may be best obtained by buoyancy, instead of weight.

For this purpose, therefore, the band of sponge is supposed to be divided into eight or more equal parts, 1 2 3 4, etc., each part being furnished with a float or buoyant vessel,  $f1$ ,  $f2$ , etc., rising and falling upon spindles,  $s s s$ , etc., fixed in the periphery of the drum; these floats being of such dimensions that, when immersed in water, the buoyancy or pressure upwards of each shall be sufficient to compress that portion of the sponge connected with it, so as to squeeze out any water it may have absorbed. These floats are further arranged by means of levers  $lll$ , etc., and plates  $ppp$ , etc., so that, when the float  $f$  No. 1 becomes immersed in the water, its buoyant pressure upwards acts not against the portion of the sponge No. 1, immediately above it, but against No. 2, next in front of it; and so, in like manner, the buoyancy of  $f$  No. 2 float acts on the portion of the sponge No. 3, and  $f$  No. 3 float upon No. 4 sponge.

Now, from this arrangement it follows, that the portion of sponge No. 4, which is about to quit the water, is pressed upon by that float, which, from acting vertically, is most efficient in squeezing the sponge dry; while that portion of the sponge No. 1, on the point of entering the water, is not compressed at all from its corresponding float No. 8, not having yet reached the edge of the water. By these means, therefore, it will be seen that the sponge always rises in a dry state from the water on the ascending side, while it approaches the water on the descending side in an uncompressed state, and open to the full action of absorption by the capillary attraction.

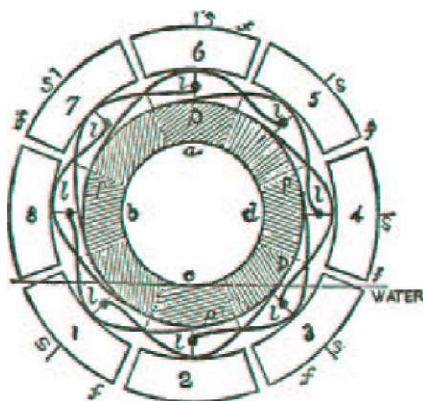

The great advantage of effecting this by the buoyancy of light vessels instead of a burthen of weights, as in Fig. 2, is that, by a due arrange-

ment of the dimensions and buoyancy of the floats immersed, the whole machine may be made to float on the surface of the water, so as to take off all friction whatever from the centre of suspension. Thus, therefore, we have a cylindrical machine revolving on a single centre without friction, and having a collection of water in the sponge on the descending side, while the sponge on the ascending side is continually dry; and if this cylinder be six feet wide, and the sponge that surrounds it one foot thick, there will be a constant moving power of thirty pounds on the descending side, without any friction to counteract it.

It has been already stated, that to perpetuate the motion of this machine, the means used to leave the sponge open on the descending side, and press it dry on the ascending side, must be such as will not derange the equilibrium of the machine when floating in water. As, therefore, in this case the effect is produced by the ascent of the buoyant floats  $b$ , to demonstrate the perpetuity of the motion, we must show that the ascent of the floats  $f$  No. 1 and  $f$  No. 3 will be equal in all corresponding situations on each side of the perpendicular; for the only circumstance that could derange the equilibrium on this system, would be that  $f$  No. 1 and  $f$  No. 3 should not in all such corresponding situations approach the centre of motion equally; for it is evident that in the position of the floats described in the above figure, if  $f$  No. 1 float did not approach the centre as much as  $f$  No. 3, the equilibrium would be destroyed, and the greater distance of  $f$  No. 1 from the centre than that of  $f$  No. 3 would create a resistance to the moving force caused by the accumulation of the water at  $x$ .

It will be found, however, that the floats  $f$  No. 1 and  $f$  No. 3 do retain equal distances from the centre in all corresponding situations, for the resistance to their approach to the centre by buoyancy is the elasticity of the sponge at the extremity of the respective levers; and as this elasticity is the same in all situations, while this centrifugal force of the float  $f$  No. 1 is equal to that of the float  $f$  No. 3, at equal distances from the perpendicular, the floats  $f$  No. 1 and  $f$  No. 3 will, in all corresponding situations on either side of the perpendicular, be at equal distances from the centre. It is true, that the force by which these floats approach the centre of motion varies according to the obliquity of the spindles on which they work, it being greatest in the perpendicular position; but, as the obliquity of these spindles is the same at all equal distances from the perpendicular, and as the resistance of the ascent of the floats is equal in all cases, the center of buoyancy will evidently describe a similar curve

on each side of the perpendicular; and consequently the equilibrium will be preserved, so as to leave a constant moving force at  $x$ , equal to the whole accumulation of water in the sponge. Nor will this equilibrium be disturbed by any change of position in the floats not immersed in the water, since, being duly connected with the sponge by the levers and plates, they will evidently arrange themselves at equal distances from the center, in all corresponding situations on either side. It may be said that the equilibrium of the band of sponge may be destroyed by its partial compression; and it must be admitted that the centre of gravity of the part compressed, according to the construction above described, does approach the center of motion nearer than the center of gravity of the part not compressed. The whole weight of the sponge is, however, so inconsiderable, that this difference would scarcely produce any sensible effect; and if it did, a very slight alteration in the construction, by which the sponge should be compressed as much outwards as inwards, would retain the center of gravity of the compressed part at the same distance from the center of motion as the center of gravity of the part not compressed.

## Chapter VII

### Liquid Air as a Means of Perpetual Motion

A few years ago air was liquefied. This was accomplished by a very high compression accompanied by a very low temperature.

It is manifest that when liquid air is removed from the extremely low temperature necessary for its liquefaction, and introduced into ordinary atmospheric temperatures, it will exert a most tremendous expansive force which can be utilized for driving machinery and thereby producing heat or electricity, or for any other purpose for which force is required. But, by the law of Conservation of Energy, the liquefied air by expansion can yield no more energy than was required to extract the heat from the air and compress it into the liquid state.

One enthusiastic individual who had worked in a plant for liquefying air announced throughout the United States of America, and perhaps throughout the civilized world, that he had a device by which the expansive force of three pounds of liquid air could be made to liquefy ten pounds, and that seven of the ten could be utilized for driving machinery, or for any other purpose for which force is required, the remaining three being utilized in the production of another ten pounds of liquid air, and so on ad infinitum. He boldly announced that thereby he had discovered an inexhaustible supply of energy at a nominal cost, whereby we could all be warmed and have our machinery of all kinds driven without the expense of gas, coal, fuel of any kind, wind, waves, tides or streams. This enthusiastic individual produced considerable excitement for a time, and then the public ceased to hear about either him or his device. He dropped out of sight and his name sank into oblivion. His claims were absurd, and the absurdity is readily apparent to anyone versed in thermodynamics or familiar with the principles of Conservation of Energy.

There was little excuse for his ever having made such pretensions or for his pretensions ever to have been seriously listened to by any one; for the principle of Conservation of Energy had years before been fully established and heralded throughout the world.

## Chapter VIII

### Radium and Radio-Active Substances Considered as a Conceived Source of Perpetual Motion

A few years ago when the remarkable properties of radium were discovered it was thought by many that here at last was the long sought solution of the problem of Perpetual Motion. Radium seemed to have the power of maintaining its own temperature *permanently* above that of surrounding bodies. Many versed in the science of thermodynamics (heat power) shook their heads in doubt. If, indeed, it were really true that the substance, radium, or any other substance had the quality of remaining permanently warmer than surrounding bodies without having heat supplied to it, then, indeed, there was an inexhaustible supply of heat, and consequently power.

Hon. R. J. Strutt (Lord Rayleigh), devised a radium clock to run on this principle, consisting of a vacuum vessel in which was suspended a radio-active substance contained in a tube. At the lower end of the tube are two gold leaves as in an electroscope. Platinum wires extended through the glass and touched the gold leaves. The other end of the platinum wires are extended to connect with the earth. The radio-active substance electrifies the gold leaves and causes them to be extended, and upon being extended they come in contact with the platinum wires and their charge of electricity is lost, being conducted through the wires and dispersed in the earth, and the leaves losing their charge fall by the force of gravity from the wires back to their position near the tube containing the radio-active substance to be again charged, to again move to and touch the platinum wires, and again lose their charge ; this process to go on indefinitely.

Here, indeed, was Perpetual Motion, except for the fact that further and more refined experiments and investigations demonstrated that radioactive substances are not permanently radio-active, but gradually, though very slowly, lose their radio-activity just as a fire will finally burn out, no matter how slowly it burns, or just as an electric battery will finally lose its charge and become exhausted.

This loss, however, of radio-active energy in radio-active substances is so slow that it is said the Strutt clock will run for over one thousand years. But the fact that it will not run permanently, and that the motion is the result of energy supplied by the radio-active substance, and is not supplied by the mechanism itself, deprives it of any right to be called a solution of the problem of self-motive power.

It should be noted that Hon. R. J. Strutt (Lord Rayleigh) of England, who devised the radium clock, above mentioned, is not to be classed with the ordinary Perpetual Motion enthusiast. He was, and is, in fact, a man of very great scientific ability and attainments, and has to his credit many actual and splendid achievements demonstrating him to be a genius of the rarest and most exalted type. His radium clock is founded on correct principles, and surely a clock that will run one thousand years without having power supplied from an outside source is worth while. It should be here also mentioned that the force derived from radio activity in the manner it is applied in the Strutt clock is very slight, and the instrument necessarily extremely delicate.

## Chapter IX

### **Perpetual Motion Devices Attempting Its Attainment by a Misconception of the Relation of Momentum and Energy**

The author, within twenty years last past, has had his attention called by two different persons, each ignorant of the efforts of the other, who were seeking to obtain Perpetual Motion by utilizing certain physical facts concerning Momentum and Energy. These facts and the principles out of which they grow are familiar to all who understand thoroughly, even the rudiments of physics; but to persons who are inclined to mechanics, but who have never had the advantages of the presentation of clear principles, they are confusing, and it is surprising that they have not become more fertile fields for Perpetual Motion workers. However, we are unable to find any written or printed account or description of a plan or device of that kind, and our information is confined to instances that have been brought to our personal observation, and concerning which the advice and counsel of the author was sought.

The worker in each case was a man of more than ordinary natural intelligence, and with a bent for mechanical pursuits and reflection. Each had taken a course in what is conventionally called High School Physics.

The idea in each case was so novel and interesting that we deem the presentation worth while. They were so nearly alike that instead of attempting to narrate what they said, we will endeavor in our own way to present the idea, and then to give our explanation, showing wherein lay their error. The following definitions and laws of physics may be regarded as established:

## Momentum

*Momentum* is the quantity of motion of a moving body, and is the velocity multiplied by the weight.

Thus, a body weighing two pounds, moving at four feet per second, may be represented as having a momentum of eight.

A body weighing two pounds moving at the rate of six feet per second may be said to have a momentum of twelve.

A body weighing ten pounds moving at the rate of ten feet per second will have a momentum of one hundred—and so on.

Now, a step further. A body in motion striking another body free to move will lose part of its motion, and will impart some of its motion to the body moved against. The aggregate momentum after the striking is the same as before that is to say—if a body weighing ten pounds have a velocity of twenty feet per second, its momentum we will call two hundred. Now, if in moving it strike another body either larger or smaller its motion will be somewhat retarded, and the body struck will possess some motion.

Multiply the weight of each by its motion after the striking, and it will be found that the sum of the products is two hundred. This may be illustrated by swinging balls like pendulums to cords of equal length from a beam, having the arrangement such that balls of different materials and sizes can be substituted at liberty. If a body be drawn back parallel to the beam, and released so as to swing against another swinging body, both will have motion. This motion will, in some cases be a rebounding motion, as in the case of a small elastic body swinging against and striking a larger elastic body, but in all cases the sum total of the momentum after the impingement is the same as before.

The following statement of the law then, is deducible:

*The Momentum* of one body in motion may be made to impart momentum to another body, the amount of momentum lost by the former being exactly equal to that thus acquired by the latter.

Before leaving these remarks on momentum the reader should observe carefully what momentum is and bear in mind it is the *quantity of motion* possessed by a moving body, and has to do only with *mass* and *velocity* and takes no account of distance passed through.

## Energy

Energy is the *capacity to do work*, and the energy of a moving body is the amount of *work* it will do, i. e., the *distance* it will move against a resistance by virtue of its tendency to move, before being brought to a state of rest.

Now note, and note carefully, that the amount of *energy is proportional* to the mass, and to the *square* of the velocity.

Note this carefully: Any body in motion *has both momentum and energy*. Its momentum is proportional to its velocity; its energy to the *square* of its velocity. If the velocity be doubled, the momentum will be doubled, but its energy quadrupled. If the velocity be trebled, its momentum will be trebled, but its energy increased nine-fold.

It is important that the student get clearly what is meant by saying that Energy is the *capacity to do work*, and is proportional to the square of the velocity.

The capacity to do work means the capacity to move against resistance, i. e., to overcome resistance. The word "work" being used in a purely mechanical sense and in that sense it is used whether the result accomplished is destructive or beneficial.

A revolving fly wheel will run machinery for some time after the application of force has ceased. This is doing work, and represents energy.

A bullet fired from a gun will accomplish destruction before having its motion arrested. This is work—energy.

If a boy throw a ball into a snow bank, its motion will sink it into the snow, but not far, the resistance of the snow will soon bring the ball to rest. The ball overcomes resistance in passing through the snow until it is brought to rest, and thus it does the *work* of forcing itself through the snow, and possesses the *energy* necessary to do that work.

The overcoming of the resistance of the air by a moving body is work. A steamboat will move for some time in water after the steam has been turned off. The overcoming of the resistance of the water is work, and by virtue of the motion of the boat when the steam was turned off it possessed the energy to do the work of forcing itself for some time through the resistance of the water.

The Perpetual Motion worker in each case had reasoned himself into this conclusion : That the same energy will impart the same *acceleration* of velocity, regardless of the velocity at the beginning of the application of energy. That the same amount of energy or work necessary to impart to a body a velocity of ten feet per second will increase that velocity to twenty feet per second, or from twenty feet per second to thirty feet per second. In other words, that the same amount of energy, and only the same amount of energy is required for a given *increase* in velocity without regard to the initial velocity. This appears plausible, and almost self-evident. We believe the great majority of people, other than mechanical engineers would, upon presentation of the theory accept it as axiomatic, and as a matter of course. The fallacy becomes manifest only from a critical and technical examination of the Laws of Momentum and Energy.

The Perpetual Motion worker had learned from his text-books that if the velocity be *doubled*, the energy would be *multiplied by four*. His idea was to so arrange his mechanism that he would apply the amount of energy to move a fly wheel free to revolve, from a position of rest to a revolving velocity of ten revolutions per second. Then apply again the *same amount of energy*, and accelerate that velocity from ten revolutions per second to twenty revolutions per second. Thus, the energy at the end of the second second would be four times what it was at the end of the first second. But to make it so, only double the amount of energy had been applied that had been expended at the end of the first second. Thus, he reasoned, his machine was by virtue of its structure, accumulating energy, and this energy could be used one-half to continue the motion of his machine, and the other half to run other machinery, or for any other purpose for which energy might be desired.

Wherein lies the fallacy of this supposition?

We will now endeavor to explain. And for the young student to get the explanation fully, it will be necessary for him to pay the closest attention to what we here state.

A force, for instance the pressure of the finger or the hand, equal to one pound against a body free to move, will, we will say, move that body in one second of time through a space of ten feet, and at the end of that second the body will have a velocity of twenty feet. It is manifest that at the end of the second the velocity will be twenty feet per second for its initial velocity is zero, and its average velocity ten feet per second, the acceleration being, of course, presumed uniform.

Now, it is *not* true as the Perpetual Motion worker had assumed that the same energy—i. e., the same work that is required to increase the velocity from zero to ten feet per second will increase the

velocity from ten feet per second to twenty feet per second, and in that assumption lay the fallacy of our friends who were thus seeking Perpetual Motion.

The greater the velocity, the more energy is required to impart a given acceleration. To increase the velocity from ten feet per second to twenty feet per second, the applied force must continue through one second of time, and more energy is required to follow a rapidly moving body, and continue to apply to it a given force for one second than would be required to follow and maintain the application of the same force to a body moving more slowly the *distance* traveled is greater in one case than in the other.

It must be plain that if the moving body have a velocity at the end of the first second of twenty feet per second, it will, at the end of the second second, with the same pressure (force) continued against the same resistance, have a velocity of - forty feet per second, and at the end of three seconds have a velocity of sixty feet, and at the end of four seconds a velocity of eighty feet, and so on.

Now, at the beginning of the second second it had a velocity of twenty feet, and at the end of that second a velocity of forty feet. It therefore, traveled through that second with an average velocity of thirty feet and, of course, during the second second traveled exactly thirty feet. It traveled ten feet the first second, and if it traveled thirty feet the second, then in the two seconds it traveled forty feet—four times as far as it traveled the first second. At the beginning of the third second it had a velocity of forty feet, and at the end of the third second a velocity of sixty feet. The average velocity then for the third second would be one-half the sum of forty feet and plus sixty feet—that is to say, it would be fifty feet, and that would be the distance traveled during the third second. The first second it traveled ten feet, the second second thirty feet, and the third second fifty feet, making a total in three seconds of ninety feet—that is to say, in three seconds it traveled nine times as far as in one second.

It will be noticed from the above that the velocity is proportional to the number of seconds, but that the distance traveled is proportional to the *square* of the number of seconds, and also proportional to the square of the velocity.

Momentum is mass multiplied by velocity; energy is measured by the distance through which a body will move against a given resistance. Should you prop up one wheel of a carriage and revolve the wheel, then with the pressure of the finger or the thumb on the hub as a brake, stop it, it will be found that (omitting the effect of atmospheric resistance), the wheel will make four times as many revolutions before stopping with a doubled velocity; nine times as many with a trebled velocity.

Falling bodies afford the most perfect illustration of the principle of Momentum and Energy, and are so commonly used to illustrate those principles that many students get the idea that the application of those principles is confined to falling bodies, and do not realize that they extend generally through the field of mechanics.

A falling body is, of course, acted upon by gravity with uniform force equal to the weight of the falling body, and that force continues to follow the falling body and to be applied uniformly and equally, however slowly, or rapidly the body may be falling. And, omitting atmospheric resistance, the body is absolutely free to move except for its natural tendency to remain at rest, or at uniform velocity. It is well known that a body falls (almost exactly) sixteen feet in one second, and at the end of one second has a velocity of thirty-two. During the second second it falls through a distance of forty-eight feet, and during the third second a distance of eighty feet. In two seconds it falls sixty-four feet, and in three seconds one hundred twenty-eight feet, and so on. Thus, it will be observed that the velocity is proportional to the time during which it has fallen, but that the distance fallen in any number of seconds is proportional to the square of the time.

This, indeed, is a property of numbers, and results from mathematical law. If the reader will form a series of numbers, setting down any number for the first term of the series, adding to it its double for the second term, and adding to the second term double the first term for the third, and adding double the first term to the third term for the fourth, and so on in other words, form any increasing arithmetical series with double the first term for the common difference, he will discover that the *sum of all the terms is equal to the first term multiplied by the square of the number of terms.* Thus:

1st Term 2nd Term 3rd Term 4th Term 5th Term 5 15 25 35 45

In the above series the sum of the first two terms is 20, which is 4 times the first term. The sum of the first three terms, i. e.,  $5 + 15 + 25 = 45$ —nine times the first term. The sum of the first four terms, i. e.,  $5 + 15 + 25 + 35 = 80$ , sixteen times the first term, and so on.

It will thus be seen that Momentum and Energy are entirely different, although co-related; that momentum relates to velocity, which includes the element of time, whereas energy relates to the amount of work done, and may be represented by a force operating against a certain resistance, through a certain distance, entirely irrespective of time. The energy is the same with the same force operating against the same resistance, through the same distance whether the time consumed be great or small. It takes as much energy in the aggregate to wind up a bucket from the bottom of the well if done slowly as if done quickly.

It would seem hardly necessary to do so, and yet it is worth while remarking that the amount of energy necessary to impart a given motion is exactly the amount of Energy that will be required to arrest that motion, and represents the amount of Energy possessed by the moving body by virtue of its motion. Work done, i. e., Energy applied in giving motion is there in that motion, ready to be returned in exactly an equal quantity—no more—no less. In all the considerations in this chapter no notice is taken of loss by friction or atmospheric resistance. We are considering pure mechanics and the laws governing them only. In actual mechanical devices it is always necessary to make allowance for atmospheric, frictional and other unavoidable resistances.

## Chapter X

### **The Alleged Inventions of Edward Sommerset, Sixth Earl and Second Marquis of Worcester, and of Jean Ernest Eli-Bessler (Councillor) Orffyreus**

More interest has been taken, and more has been said and written concerning the claimed inventions of the men forming the subject of this chapter than of all other Perpetual Motion devices known to history. The reason is not difficult to explain. It was the rank and eminence of the inventors and of others whom they induced to take an interest in their inventions, and to proclaim them to the world. Intrinsically, neither their claims nor their devices are entitled to any more notice than are those of the humblest mechanic that ever labored to attain Perpetual Motion. However, so much has been said and written concerning them that they have an historical value and interest. Then, too, the interest taken in their inventions brought forth some splendid discussions which necessarily involve in a general way, at least, the entire question of Self-Motive Power. The historical interest attaching to their inventions and the discussions concerning them, entitles them to more than a passing notice in this book.

They were not co-laborers; they were not even compatriots, nor contemporaries. Worcester was an Englishman and Orffyreus a Frenchman, though most of his labors were in what is now Germany. The former died thirteen years before the latter was born.

Edward Sommerset, of England, Sixth Earl and Second Marquis of Worcester, was born in the year 1601, and died in 1667. He was famous not only for his noble birth and family rank, but for personal attainments. He was the author of a work entitled "Century of Names and Scantlings of Such Inventions as at Present I Can Call to Mind Have Tried and Perfected" (1663), which has often been reprinted, and is usually referred to simply as "Century Inventions." He was very prominent in public life; was greatly interested in mechanical experiments, and made valuable suggestions, inventions and improvements in connection with the use of steam as a motive power.

Henry Dircks, who is so frequently mentioned in this book, wrote a book which was published in 1865, entitled "Life, Times and Scientific Labors of the Second Marquis of Worcester." The Marquis appears to have been all his life greatly interested in science, mechanics and mathematical contrivances. His first wife died in 1635, and it seems probable that thenceforth he became and remained more than ever devoted to mechanics, and sometime after that period announced a successful Perpetual Motion machine, the gist of all known information concerning which appears from the articles and discussions hereinafter set forth in this chapter.

Jean-Ernest Eli-Bessler (Councillor) Orffyreus was born in 1680, near Zittan, Alsace, France. He was a man of great ability and attained an eminent place in public life. The title "Councillor," he acquired by having been selected Councillor to the Prince of Hesse Castle. The best information concerning him indicates that he was of very erratic temperament, given to fits of melancholy and extreme anger. In early life he was a student of theology and medicine, but his penchant was really for mechanics. He claimed that in his search for whatever might prove curious and valuable he had discovered Perpetual Motion, and that between the years 1712 and 1719 he had made two successfully working machines on his system. The following discussions disclose all that is known of the claimed inventions of these two distinguished Perpetual Motion workers.

The alleged inventions of the Marquis of Worcester is stated by him in the 56th article of his book entitled "Century of Names and Scantlings of Such Inventions as at Present I Can Call to Mind to Have Tried and Perfected" and translated from the ancient English style in which his book is written into modern style of English, reads as follows:

The inventor offers the accompanying sketch, with description of an Hydraulic Mover, for communicating power to machinery, and recently invented by him: "To provide and make that all the weights of the descending side of a wheel, shall be perpetually farther from the center, than those of the mounting side, and yet equal in number and heft to the one side as the other. A most incredible thing, if not seen; but tried before the late King (of blessed memory) in the Tower by my directions, two extraordinary ambassadors accompanying his Majesty, and the Duke of Richmond, and Duke of Hamilton, with most of the Court attending him. The wheel was fourteen foot over, and had forty weights of fifty pounds apiece. Sir William Balfore, then Lieutenant of the Tower, can justify it, with several others. They all saw, that no sooner these great weights passed the diameter line of the lower side, but they hung a foot farther from the center; nor no sooner passed the diameter line of the upper side, but they hung a foot nearer. Be pleased to judge of the consequence."

In October of 1719, Orffyreus published a small book, or pamphlet, both in German and Latin, entitled "Perpetual Motion Triumphant, by Orffyreus." The book commences:

It is a notorious fact that Perpetual Motion has not only been sought after by ingenious mathematicians and artists with more or less expense, but many have arisen here and there pretending that they have made the discovery. Nevertheless, it appears that to carry out this most

subtle mechanical idea, namely, to make a dead material not only move itself, but lift weights and perform work, even the most profound mathematicians and the most learned people have continually fallen into error. It is no less notorious that those who have so sought, not only refuse their consent, but have set their seal on the discovery as an unsolvable problem.

On a subsequent page he proceeds thus:

When I, at last, an unworthy man, was made an instrument in God's hands to solve this longlooked-for and valuable secret, and to give a representation, proposition and instruction on this rare invention; also to publish and propound it to all the world, no longer do I doubt, nay I presume, that as the discoverer I possess it, after many years of scrupulous doubts, much calumny and exasperation from all my enemies.

He speaks of his opponents under four divisions: First, the scientific world; second, persons in high authority; third, the public in general; and fourth, the press; observing

Now my wish was to convince the world that this illiberal, rude and inhuman treatment was false, yet God's providence has brought to my help, protection and succour the mighty Prince Lord Charles, Landgrave of Hesse.

On a subsequent page he indulges in the following sycophantic adulation of the Prince of Hesse Castle, and suggestion of the description of his claimed device:

It has not only pleased this mighty Prince to protect me against my numerous enemies, but also to give me house-room in his princely Castle of Weissenstein, near Cassel; to name me one of his most honored servants, and restore me in a measure all the honor and means that I had lost in my native country; wishing no doubt to give to Hesse Cassel the high honor which belonged to Saxony by right. In gratitude for all these gracious acts, I consented to give another example of my Perpetuum Mobile machine. I put all in fresh order, and began work in all possible haste, doing everything in the manner of those I had already made and destroyed, with only a few changes in the dimensions of the so-named turning-wheel. For as a grindstone may be called a wheel, so may the principal part of my machine be named. The outward part of this wheel is drawn over or covered with waxed linen in the form of a drum. This cylindrical basis was 12 Rhenish feet in diameter, the thickness from 15 to 18 inches, the middle axle 6 feet long and 8 inches in thickness. It is supported in its movement on two pointed steel balance-pegs, each 1 inch thick; and the wheel is vertically suspended. The movement is modified by two pendulums, as shown in the engraving at the end of this book. The inward structure of the wheel is of a nature according to the laws of mechanical perpetual motion, so arranged that by disposed weights once in rotation they gain force from their own swinging, and must continue their movement as long as their structure does not lose its position and arrangement. Unlike all other automata, such as clocks or springs or other hanging weights which require winding up or whose duration depends on the chain which attaches them, on the contrary, these weights are the essential parts and constitute perpetuum mobile itself; as from them is received the universal movement which they must exercise so long as they remain out of the center of gravity; and when they come to be placed together, and so arranged one against another that they can never obtain equilibrium, or the *punctum quietus* which they unceasingly seek in their wondrous speedy flight, one or other of them must apply its weight vertically to the axis, which in its turn will also move.

The author and inventor then suggests the following uses of his machine: "raising weights, raising stampers, water," etc. He criticises all critics of his scheme and denounces them as cunning rogues, and fools who are contemptibly endeavoring to overthrow an incontestable fact. He makes a quadrupled dedication of his device:

1. To God,
2. To the Public in General,
3. To Men of Learning,
4. To Himself as Discoverer,

and he very modestly suggests a method by which he could be approached on the subject of selling the secret of his machine for one hundred thousand rix-thalers, and points out the great importance to the public of such an acquisition. The book contains a cut of his device with the following very brief explanation:

Number 1 shows the entire size wheel; 2, a cord wound round principal axle; 3, the wheel or to guide the cord; 4, the cord through a window and over 5, pulley; 6, the box of stones or lowered; 7, the lock to motion; 8, the pendulum with weights; 9, a winch-handle on the pendulum; and 10, shows and below transparent, so that the and can be moved about.

In 1720 the following article was in the "Gentleman's Magazine," Wheel:

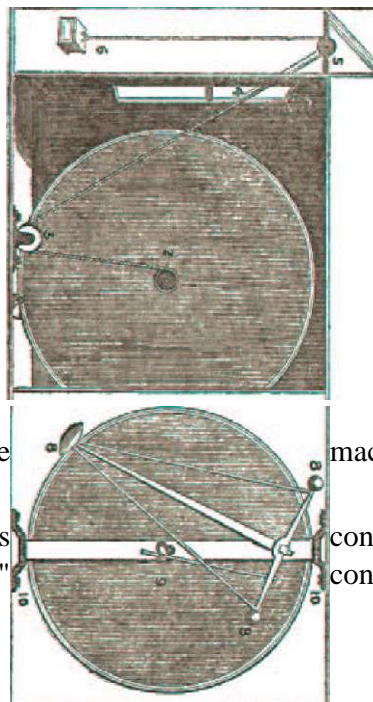

of the  
 the  
 pulley  
 passed  
 another  
 raised  
 prevent  
 three  
 acting  
 above  
 machine stands clear

contributed to and published concerning the Orffyrean

MR. URBAN: Being an admirer of improvements in mechanics and desirous of seeing the perpetual motion discovered, I was much pleased on reading, some time ago, an account of the automaton constructed by Orffyreus in two letters, one from Professor 's Gravesande to Sir Isaac Newton, the other from Baron Fischer to Dr. Desaguliers, with the testimonial of the Landgrave of Hesse-Cassel (who had seen the inside of it) in favor of its construction. To which are added some remarks by William Kenrick, the writer of the pamphlet, who takes that opportunity to propose a subscription for a similar machine, which he says he has contrived and denominated a Rotator.

It is much to be lamented that the learned did not examine more strictly into the merit of Orffyreus's wheel; but, on the contrary, being prepossessed with a notion of the impracticability of the perpetual motion, suffered it to be neglected, and at last destroyed by the hands of a disappointed mechanic, who, with unwearied application and steady perseverance, had brought it to perfection. I wish we may not again let slip an opportunity of becoming acquainted with an invention, which, when made public, will reflect honor on the inventor, and be of the utmost utility to the world. Such, I would hope, is the rotator mentioned by W. Kenrick; for, unless his discovery were real, I cannot think that he would have taken the liberty to express himself as he does in p. 26, etc., "The inventor flatters himself that, if the contents of the foregoing pages are seriously attended to, and it be farther considered, that not a penny of the proposed premium is required, till the subscribers are fully satisfied of the reality and utility of the invention, his proposal will not be treated with so mortifying a neglect as that of Orffyreus." Again he says, "If it does not supply the place of a first mover, at the expense only of the construction and repair of a simple wheel subject to very little friction, and that in all such engines and machines, even from the slightest piece of clockwork to the waterworks of Marli or London-bridge, he expects nothing for his discovery, but to stand exposed to the contempt that will be justly thrown on him for having so miserably mispent his time, and frivolously engaged the attention of the public."

Now, I think that W. Kenrick's proposals are very fair; and should be glad to be informed, whether any attention has been paid to them, and whether Sir Isaac Newton took any notice of the letter addressed to him by Professor Gravesande. I shall consider it as a favor if any correspondent will oblige me with an answer to these particulars.

A CONSTANT READER.

In 1721 Rev. Dr. J. T. Desaguliers, LL.D, F.R.S., contributed to an English periodical entitled "Philosophical Transactions" the following article concerning the device of the Marquis of Worcester, and the Orffyrean Wheel:

REMARKS ON SOME ATTEMPTS MADE TOWARDS A PERPETUAL MOTION; BY THE  
REVEREND DR. DESAGULIERS, F.R.S.

The wheel at Hesse-Cassel, made by Monsieur Orffyreus, and by him called a perpetual motion, has, of late, been so much talked of on account of its wonderful phenomena, that a great many people have believed it to be actually a selfmoving engine; and accordingly have attempted to imitate it as such. Now, as a great deal of time and money is spent in those endeavours, I was willing (for the sake of those that try experiments with that view) to show that the principle which most of them go upon is false, and can by no means produce a perpetual motion.

They take it for granted that if a weight descending in a wheel at a determined distance from the center, does, in its ascent, approach nearer to it; such a weight in its descent will always preponderate and cause a weight equal to it to rise, provided it comes nearer the center in its rise; and accordingly as itself, rises, will be overbalanced by another weight equal to it; and, therefore, they endeavour by various contrivances to produce that effect as if the consequence of it would be a perpetual motion.

But I shall show that they mistake one particular case of a general theorem, or rather a corollary of it, for the theorem itself. The theorem is as follows:

THEOR. If one weight in its descent does, by means of any contrivance, cause another weight to ascend with a less momentum or quantity of motion than itself, it will preponderate and raise the other weight.

COR. 1. Therefore, if the weights be equal, the descending weight must have more velocity than the ascending weight, because the momentum is made up of the weight multiplied into the quantity of matter.

COR. 2. Therefore, if a leaver or balance have equal weights fastened or hanging at its ends, and the brachia be ever so little unequal that weight will preponderate which is farthest from the center.

SCHOLIUM.—This second corollary causes the mistake; because those who think the velocity of the weight is the line it describes, expect that

that weight shall be overpoised, which describes the shortest line, and, therefore, contrive machines to cause the ascending weight to describe a shorter line than the descending weight. As for example, in the circle A D B a (Fig. 3) the weights A and B being supposed equal, they imagine that if (by any contrivance whatever) whilst the weight A describes the arc A a, the weight B is carried in any arc, as B b, so as to come nearer the center in its rising than if it went up the arc B D; the said weight shall be overpoised, and consequently, by a number of such weights a perpetual motion will be produced.

This is attempted by several contrivances, which all depend upon this false principle; but I shall only mention one which is represented by Fig. 4, where a wheel having two parallel circumferences, has the space between them divided into cells, which being curved, will (when the wheel goes round) cause weights placed loose in the said cells to descend on the side A at the outer circumference of the wheel, and on the side D to ascend in the line B b b b, which comes nearer the center and touches the inner circumference of the wheel. In a machine of this kind the weights will indeed move in such a manner if the wheel be turned round, but will never be the cause of the wheel's going round. Such a machine is mentioned by the Marquis of Worcester in his "Century of Inventions" in the following words, No. 56:

"To provide and make that the descending side of a petually farther from the the mounting side, and yet heft to the one side as the incredible thing, if not seen; late King (of blessed Tower by my directions, ambassadors

Majesty, and the Duke of Duke of Hamilton, with attending him. The wheel over and had forty weights piece. Sir William Balfore, then Lieutenant of the Tower, can justify it with several others. They all saw that no sooner these great weights passed the diameter line of the lower side, but they hung a foot farther from the

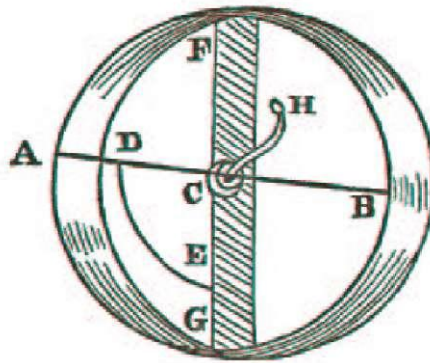

all the weights of wheel shall be per-center than those of equal in number and other. A most but tried before the memory) in the two extraordinary accompanying his Richmond, and most of the court was fourteen foot of fifty pounds a

piece. Sir William Balfore, then Lieutenant of the Tower, can justify it with several others. They all saw that no sooner these great weights passed the diameter line of the lower side, but they hung a foot farther from the

center; nor no sooner passed the diameter line of the upper side, but they hung a foot nearer. Be pleased to judge of the consequence."

Now the consequence of this and such like less than a perpetual motion; and the fallacy is any weight is not the line which it describes in that it rises up to or falls from, with respect to its center of the earth. So that when the weight arc  $A a$ , its velocity is the line  $A C$ , which shows descent (or measures how much it is come the earth), and likewise the line  $B C$  denotes the  $B$ , or the height that it rises to when it ascends in instead of the arc  $B D$ : so that in this case in its ascent be brought nearer the center or not, which it ought to do in order to be raised up by weight in rising nearer the center of a wheel velocity, but be made to gain velocity in

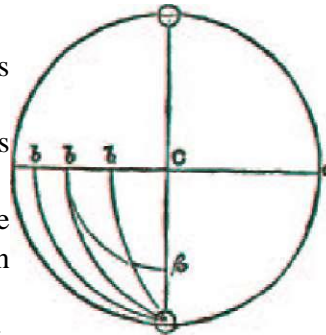

machines, is nothing this: The velocity of general, but the height distance from the (Fig. 3) describes the the perpendicular nearer to the center of velocity of the weight any of the arcs  $B b$ , whether the weight  $B$  it loses no velocity the weight  $A$ . Nay, the may not only lose of its proportion to the

velocity of its counterpoising weights that descend in the circumference of the opposite side of the wheel; for if we consider two radii of the wheel, one of which is horizontal, and the other (fastened to and moving with it) inclined under the horizon in an angle of 60 degrees (Fig. 5) and by the descent of the end  $B$  of the radius  $B C$ , the radius  $C D$  by its motion causes the weight at  $D$  to rise up the line  $p P$ , which is in a plane that stops the said weight from rising in the curve  $D A$ , that weight will gain velocity, and in the beginning of its rise it will have twice the velocity of the weight at  $B$ ; and. consequently, instead of being raised, will overpoise, if it be equal to the last mentioned weight. And this velocity will be so much the greater in proportion as the angle  $A C D$  is greater, or as the plane  $P p$  (along which the weight  $D$  must rise) is nearer to the center. Indeed, if the weight at  $B$  (Fig. 3) could, by any means, be lifted up to  $b$ , and move in the arc  $b b$ , the end would be answered; because then the velocity would be diminished and become  $b C$ .

EXPERIMENT (Fig. 5). BCD, whose brachia are bent in an angle of 120 degrees, is moveable about that point. In this case a weight of two pounds at B of the horizontal part will keep in equilibrium a weight hanging at the end D. But if one pound be laid upon the end that in the motion of D this weight is made to rise P p (which divides in half to C B) the said weight will keep in equilibrium two pounds at B, as having twice the velocity of it when the lever begins to move. This will be evident, if you let the weight 4 hang at D, whilst the weight 1 lies above it: for if then you move the lever the weight 1 will rise four times as fast as the weight 4.

(Fig. 4.)

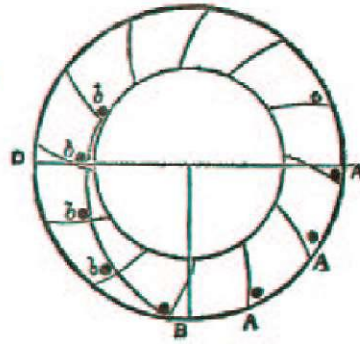

Take the lever equal in length, pivoted at C and as its center: in this hanging at the end of the lever will of four pounds a weight of one D of the lever, so along the arc p A, up against the plane the line A C equal

In 1770 Dr. William Kenrick published "A Lecture on the Perpetual Motion." In it he has the following to say concerning the alleged inventions of the Marquis of Worcester, and Councillor Orffyreus, and Perpetual Motion in general. The following comments on the lecture verbatim from Dircks: excerpts of and are taken

(Fig. 5.)

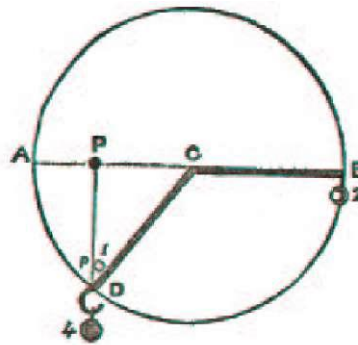

The mere exhibition of a moving machine without a mechanism, or the which its motion is begun could produce no conviction. Orffyreus and his machine Scarce fifty years ago that mechanician exhibited a at Hesse Cassel, the whose operation was many weeks under the most exact caution of the Landgrave of that Principality, whose testimony of such operation, as well as in favor of its construction (to the secret of which he was admitted), was given in the

self-display of its principles on and continued, tion. The fate of is a proof of this. whimsical perpetual motion constancy of experienced for

most explicit and determinate form. And yet, because Orffyreus could not display the mechanism without the previous assurance of a premium of 200,000 florins (near twenty thousand pounds), or because he would not or could not discover the principles on which it acted, his pretensions were neglected, his machine was destroyed by his own hands, and his life made a sacrifice to the chagrin attending his disappointment. Twenty years had he racked his brains for invention, and expended a patrimonial competence with parsimony in prosecuting his design. And when success inspired the hope of reward, he found his ingenuity suspected of imposture, and his industry rewarded with contempt.

Whether any of his successors in the same pursuit will meet with a better fate is at length to be determined. One species of our predecessor's merit, however, I (adds Dr. Kenrick) presume myself at least entitled to, that of perseverance; it being now fifteen years since I first engaged in this undertaking, which I have since pursued with almost unremitted assiduity, and that not only at a considerable waste of time and expense, but under the constant mortification of hearing it equally ridiculed by those who do know, and by those who do not know, anything of the matter.

It is, indeed, generally supposed, and as confidently affirmed, that the mathematicians have published demonstrations of the impossibility of a perpetual motion. But I can safely take upon me to affirm that no such demonstration was ever published by any. Within these twelve years past the mathematicians who deny the possibility of a perpetual motion have been repeatedly and publicly called upon, both in the foreign and English prints, to produce a single instance of these demonstrations. They have not done it. They might have produced, indeed, the demonstrations of Huygens, De la Hire, and others to prove, as Desaguliers very properly expresses it the fallacy of the schemes of most of the pretenders to the perpetual motion. They proved nothing more; and this was so far unnecessary in that the fallacy evidently appeared in the discovery of the principle on which they were founded.

This was done in the last century by the celebrated Marquis of Worcester, in the presence of the King and his Court, at the Tower, by the exhibition of a wheel so contrived that in revolving on its axis it carried up several weights nearer its center on one side than they descended on the other. The scheme was plausible and to appearance practicable; but, though the wheel was polite enough to turn about while his Majesty was present, it could not be prevailed upon to be so complaisant in his absence. The mathematicians avenged themselves of the short triumph of the mistaken Marquis, but were equally mistaken themselves in thinking they had routed the problem or that in hunting down the jackal they had destroyed the lion. The perpetual motion survived; it had still its advocates; Professor Gravesande and John Bernouille maintained its practicability, the former giving his testimony in favor of Orffyreus's machine, after a long and scrupulous examination. It is not twelve years since this testimony was republished by Dr. Allainan, the present Professor of Natural Philosophy at Leyden, whose own opinion, given at the same time, is also greatly in favor of the discovery. It is even some years later that a dissertation still more in its favor, written, if I am not mistaken, by the celebrated De Gorter of Petersburg, appeared in the "Philosophical Transactions" of Haarlem. My end is not to amuse or persuade, but, with due deference, to inform and convince. To remove every cause of objection, I must beg leave to expatiate somewhat at large on the theory of this discovery. It is with the more propriety I presume on this method, as the discovery to which I pretend has not been (as frequently happens) the effect of mechanical accident, but the premeditated result of mathematical reasoning and physical experiment. I shall proceed to elucidate the principal arguments *a priori*, that prove the practicability of a perpetual motion to be the necessary consequence of the known and established laws of nature.

Having proceeded thus far, he opens his lecture at page 7 with the introduction; and first "On the Nature of Motion in General" which, in fourteen pages, being more metaphysical than mechanical,

affords no extractable matter for our present object. Part I is "On the Cause and Effect of Motion." This elementary part is needlessly labored and elaborated through 27 pages. In the course of his remarks he states:

The discovery of a perpetual motion, says De la Hire, would be to discover a body at once heavier and lighter than itself. But this is not a fair state of the question. It is not necessary that all the parts of a perpetually-moving machine should be attached to, and inseparable from each other; which they must be, to constitute one gravitating body of a determinate weight.

He proceeds to consider the nature of the circulation of the blood, pneumatic pressure, the steel-yard, real and relative weight, and spiral action. Again, we have Hobbes, Locke, and Stewart, in the same sentence with such language as—"I could almost as readily impute ingenuity to vegetables and fossils—to the sensitive plant and the loadstone—as mediation to muscles, or cogitabundity to cockles, periwinkles and rock oysters !" In conclusions he says:

I have endeavoured to make it appear that motion is the mechanical effect of the physical action of the primary elements; that the direction of motion only comes within the province of animal intellect; that the vital system is supported by mere mechanic motion, kept up by the elasticity of the solids and the gravity of the fluids composing the animal body; that by the same means a more simple inanimate system or machine may be framed which may have the same property of continued action (or, as it is called, self-motion). And this is all that is, or can be, expected of a perpetual motion; the momentum of which may be increased to any degree, according to the weight of the bodies employed and the work required to be done.

The second part of this lecture commences with a Proem of thirteen pages:

I am induced (he says) to trespass farther by extending in like manner the subsequent divisions of it; making the second and third parts of my printed syllabus the topics of the present reading, and reserving the last part, with the concluding experiment, to the third and final lecture.

I pretend merely to the investigation of the general principles of mechanics, and even to illustrate these so far only as I conceive they relate to the immediate object of my lecture, the discovery of an artificial perpetual motion; leaving the application of such principles, in the solution of particular phenomena, or the construction of particular machines, to such as make the different arts and sciences their peculiar study.

He very prudently ends, observing:

But I beg pardon, gentlemen, for the length of this digressive introduction, and shall proceed to the more immediate subject of my lecture.

Section 1 of this lecture is "On the Composition and Combination of Motion." After discussing, in his own peculiar style, mechanical principles of motion, he adds:

It would require a volume, and that not a small one, to illustrate these subjects and support them by the necessary demonstrations and experiments. Should Providence give me life and health, therefore, they (his auditors) shall have it. Indeed, I have already spent some years in preparing such a volume for the press.

He is very prolix on gravity and motion, then commences Section 2 "On the Communication and Dissipation of Motion." Five pages are occupied in discussing motion, in popular language, in the course of which he remarks:

And as to the imperfectly elastic bodies, their power of retaining or communicating motion depends entirely on their *vis inertiae* and weight; nor can they on any occasion whatever communicate a greater momentum to another body than they themselves possess. It is sufficient for the purpose of a perpetual motion that they can do this. And, indeed, here all the difficulty lies, viz., in the means of communicating the momentum or moving force of a heavy

body to a light one. Now, the most virulent opponents to the practicability of perpetual motion have never pretended to demonstrate the impracticability of this communication. The *quomodo*, or means of effecting it, being the point in dispute. It is to this discovery that I pretend; and to show that my pretensions are well grounded, have taken the liberty to invite you to this lecture.

The lectures appear to have been illustrated by a plate having two figures of a simple apparatus used to demonstrate the action of a spring and two unequal weights; also an inflexible ruler suspended between two unequal balls with both he experimented before his auditors; but the engraving is wanting in the edition now used. In conclusion, he observes:

You see, gentlemen, I am purposely provided here with a very simple and clumsy apparatus. The perpetual motion does not need the assistance of friction wheels, or depend on the niggling nicety of tooth and pinion. If the practical part of my discovery be not superior to the manual dexterity of a village carpenter or country smith, I am satisfied. There will be no great discernment required to comprehend the design they are to put in execution. You will permit me, however, at present, to defer what I have farther to offer on the subject to another opportunity.

In 1770 Dr. Kenrick published a quarto pamphlet concerning the Orffyrean Wheel, and in the pamphlet appears the following regarding a letter from Prof. Gravesande to Sir Isaac Newton, and a letter from Baron Fischer to Dr. Desaguliers:

*A Letter from Professor's Gravesande to Sir Isaac Newton, Concerning Orffyreus's Wheel*

SIR: Doctor Desaguliers has doubtless shown you the letter that Baron Fischer wrote to him some time ago about the wheel of Orffyreus; which the inventor affirms to be a perpetual motion. The landgrave, who is a lover of the sciences and fine arts, and neglects no opportunity to encourage the several discoveries and improvements that are presented him, was desirous of having this machine made known to the world, for the sake of public utility. To this end he engaged me to examine it; wishing that, if it should be found to answer the pretensions of the inventor, it might be made known to persons of greater abilities, who might deduce from it those services which are naturally to be expected from so singular an invention. You will not be displeas'd, I presume, with a circumstantial account of this examination; I transmit you, therefore, a detail of the most particular circumstances observable on an exterior view of a machine, concerning which the sentiments of most people are greatly divided, while almost all the mathematicians are against it. The majority maintain the impossibility of a perpetual motion, and hence it is that so little attention has been paid to Orffyreus and his invention.

For my part, however, though I confess my abilities inferior to those of many who have given their demonstrations of this impossibility; yet I will communicate to you the real sentiments with which I entered on the examination of this machine. It is now more than seven years since I conceived I discovered the paralogism of those demonstrations, in that, though true in themselves, they were not applicable to all possible machines; and have ever since remained perfectly persuaded it might be demonstrated that a perpetual motion involved no contradiction; it appearing to me that Leibnitz was wrong in laying down the impossibility of the perpetual motion as an axiom. Notwithstanding this persuasion, however, I was far from believing Orffyreus capable of making such a discovery, looking upon it as an invention not to be made (if ever) till after many other previous discoveries. But since I have examined the machine, it is impossible for me to express my surprise.

The inventor has a turn for mechanics, but is far from being a profound mathematician, and yet his machine has something in it prodigiously astonishing, even though it should be an imposition. The following is a description of the external parts of the machine, the inside of which the inventor will

not permit to be seen, lest any one should rob him of his secret. It is a hollow wheel, or kind of drum, about fourteen inches thick and twelve feet diameter; being very light, as it consists of several crosspieces of wood framed together; the whole of which is covered over with canvas, to prevent the inside from being seen. Through the center of this wheel or drum runs an axis of about six inches diameter, terminated at both ends by iron axes of about three quarters of an inch diameter upon which the machine turns. I have examined these axes and am firmly persuaded that nothing from without the wheel in the least contributes to its motion. When I turned it but gently, it always stood still as soon as I took away my hand; but when I gave it any tolerable degree of velocity, I was always obliged to stop it again by force; for when I let it go, it acquired in two or three turns its greatest velocity, after which it revolved for twenty-five or twenty-six times in a minute. This motion it preserved some time ago for two months, in an apartment of the castle: the door and windows of which were locked and sealed so that there was no possibility of fraud. At the expiration of that term indeed his serene highness ordered the apartment to be opened, and the machine to be stopped, lest, as it was only a model, the parts might suffer by so much agitation. The landgrave being himself present on my examination of this machine, I took the liberty to ask him, as he had seen the inside of it, whether after being in motion for a certain time no alteration was made in the component parts; or whether none of those parts might be suspected of concealing some fraud: on which his serene highness assured me to the contrary, and that the machine was very simple.

You see, sir, I have not had any absolute demonstration, that the principle of motion which is certainly within the wheel, is really a principle of perpetual motion; but at the same time it cannot be denied me that I have received very good reasons to think so, which is a strong presumption in favor of the inventor. The landgrave hath made Orffyreus a very handsome present, to be let into the secret of the machine, under an engagement nevertheless not to discover, or to make any use of it before the inventor may procure a sufficient reward for making his discovery public.

I am very sensible, sir, that it is in England only the arts and sciences are so generally cultivated as to afford any prospect of the inventor's acquiring a reward adequate to this discovery. He requires nothing more than the assurance, of having it paid him in case his machine is found to be really a perpetual motion; and as he desires nothing more than this assurance till the construction of the machine be displayed and fairly examined before such assurance be given him. Now, sir, as it would conduce to public utility as well as to the advancement of science, to discover the reality or the fraud of this invention, I conceive the relation of the above circumstances could not fail of being acceptable. I am, etc.

In the same book appear the following animadversions by Prof. Allaman, on the neglect of Orffyreus's invention:

We see that the testimony of M.'s Gravesande was as advantageous as possible to Orffyreus, not having seen the interior of the machine, he could form no other judgment; however, that extraordinary man was not contented, for in consequence of the examination Orffyreus broke the machine, into pieces. By the accounts of M.'s Gravesande, Baron Fischer and the testimony of the Landgrave it appears clear that the wheel was not moved by any exterior agent. Orffyreus is, however, accused of being an impostor, of having imposed on the good faith of the prince, deceived M.'s Gravesande and all those who examined his\* machine. His own servant deposed against him and said that she was made to turn the wheel, and thus he has fallen into contempt; and everyone who protected him, is ashamed of him. M. de Crousaz, who was at that time at the court of Cassel, writes a letter to M.'s Gravesande dated February 3, 1729, in these terms:—'First, Orffyreus is a fool; Second, It is impossible that a fool can have discovered what such a number of clever people have, searched for without success; Third, I do not believe in impossibilities; Fourth,

One can easily imagine that persons keep a secret from which they are to receive benefit, but this fellow, hoping only to receive reputation, allows it to be tarnished by an accusation which he has in his power to disprove, if false; Fifth, The servant who ran away from his house, for fear of being strangled, has in her possession, in writing, the terrible oath that Orffyreus made her swear; Sixth, He only had to have asked, in order to have had this girl imprisoned, until he had time to finish his machine; Seventh, They publish that the machine is going to be exhibited, when suddenly those who advertise it become silent; Eighth, It is true there is a machine at his house, to which they give the name of perpetual motion, but that cannot be removed; it is much smaller, and differs from the first, inasmuch as it only turns one way."

This is what makes Orffyreus and his machine to be suspected; can it be that M. 's Gravesande was so mistaken as to be his dupe ? Let us read what he himself says in answer to M. Crousaz, which I have found among my papers, without date:—"I have deferred replying to you until I had found a paper which I wrote the day after I examined Orffyreus' machine, for although I remember well all that passed, I believe that a paper, written the day after the examination, and communicated to my Lord and all those who were with him, must have more weight.

"This is what I heard; they say that a servant under oath, turned Orffyreus' machine, being placed in an adjoining room.

"I know well that Orffyreus is a fool, but I ignore that he is an impostor; I have never decided whether his machine is an imposture or not, but this I know as certainly as anything in the world, that if the servant says the above, she tells a great falsehood.

"My Lord the Landgrave in the presence of the Baron Fischer, Architect of the Emperor, and other persons at my request, showed the supports of the machine; we saw the axles uncovered; I examined the plates or brasses on which the axles rested and in that examination there did not appear the slightest trace of communication with the adjoining room. I remember very distinctly the whole of the circumstances of that examination, which put Orffyreus in such a rage with me, that the day after he broke his machine in pieces, and wrote on the wall that, it was the impertinent curiosity of Professor's Gravesande which was the cause. I read this myself the following year, and the result of the examination is clearly explained in the paper of which I spoke to you.

"They told me several circumstances on the testimony of the servant, but I pay little attention to what a servant can say about machines, perhaps in turning her master's roast-jack she thought she saw a perpetual motion. If you know anything concerning this matter I shall feel much pleasure if you would communicate it."

It is difficult to determine what to believe about this machine. It seems to me, however, that on examining minutely the for and against Orffyreus we can come to these conclusions: 1. That Orffyreus was evidently mad, as M. 's Gravesande and M. de Crousaz both affirm; his machinery broken at different times without either reason or necessity prove this. But his was a sort of madness we do not often see: a folly fixed only on certain objects, and merits more the name of fantasticalness or whim- sicalness; this kind of folly is often accompanied by much genius, and when persons of this disposition apply themselves solely to one subject, as it appears he did, it is not surprising to find them making discoveries which had escaped the sagacity of wiser people. Thus I do not wish to agree with M. de Crousaz, that it is incredible that a madman, such as Orffyreus should have found out something that learned men have searched for unsuccessfully. Added to this he is mistaken in saying that Orffyreus could hope for no other reward for his secrets than mere reputation: for he expected a considerable profit seeing that he demanded for it 200,000 florins. 2. No exterior agent moved the machine; if it were a servant that moved it, would it not have been apparent to eyes so searching as those that

made the examination, or to the Landgrave, who had seen the interior of the machine? Besides how can any one imagine that a wheel of so great a volume could have been moved by such a cause, a cause which would act simply on the axle in crossing the supports, and which must have been so small as to have escaped the most rigorous examination? 3. If the servant has not been paid to depose against Orffyreus, what does her testimony prove? Only that her master made her believe that by turning a little wheel, she moved the whole machine, and we can fancy a singular character, such as he was might have done this to prevent the curiosity of those who sought to penetrate his secret; M.'s Gravesande's opinion of this strange character is such that he doubts not his whimsicalness prevented him from making a new machine. 4. It must be confessed that this wheel was a very remarkable mechanical phenomenon, and this is all we can say, not knowing more than the preceding details; it were too much temerity to say that this invention was a perpetual motion, as much as it would be wrong to call it an imposture, seeing that no exterior agent was employed.

Dr. Kenrick proceeds to state that:—The celebrated John Bernoulli, speaking of the above demonstration, in a letter to the author, remarks that it is very just; the principle assumed necessarily involving an augmentation of force, viz., a perpetual motion. But this, continues he, is no more than Leibnitz had long before demonstrated in his dispute with Papin and others.

Having thus occupied twenty-three pages in fencing himself with a screen against the ridicule he appears to have so much dreaded, and reasonably anticipated from the many authors he had himself similarly treated in the "London Review," we are informed that, An accidental conversation, many years ago, on the spot where Orffyreus exhibited his machine, awakened the author's curiosity and directed his attention to an object which he has ever since occasionally pursued. The experiments he has made, even so long since as the year 1761, convinced him so far of the reality of Orffyreus' discovery, that he applied for letters-patent to secure an exclusive right to the construction of a similar machine; which he had contrived and denominated A ROTATOR. Before his patent, however, was expedited, he reflected that, though the model he had constructed might serve to remove the prejudices of the public, it was not so well calculated as it might be, to answer the practical purposes of so important a discovery. To the improvement of the Rotator, therefore, has he long since dedicated all the time and attention he could possibly spare from his other, more immediately necessary, pursuits.

Nothing can be more flimsy than the statement here made, and the next sentence would seem to explain the true state of the case. He proceeds: "Not that he believes he has contrived quite so many different machines as Orffyreus did, though he has been almost as many years engaged in the like undertaking; he has, nevertheless, both contrived and constructed a considerable number, many of them useless as costly, except indeed as they served to assist him in completing his invention."

His invention, however, was *not* complete; the very model of it was unsatisfactory. Like Orffyreus, he had spent nearly twenty years, making numerous, and some costly, machines. He no doubt had his own misgivings, and wished to reimburse himself for the great outlay he must have incurred during that long period, before the bubble finally burst! However, poor man, he died nine years after publishing this elaborate advertising prospectus, which concludes: "Such bodies corporate, private companies or individuals, as are interested in the construction or use of considerable mechanical engines, or are disposed to encourage the present discovery, may receive any further information they require, on applying to the inventor, WILLIAM KENRICK, Charles street, St. James's Square, March 1, 1770."

In 1803, Dr. Charles Hutton, LL.D., and F. R. S., contributed in a brief work entitled, "Recreations in Mathematics and Natural Philosophy," gave the following notice to the Orffyrean Wheel: The

perpetual motion has been the quicksand of mechanics, as the quadrature of the circle, the trisection of an angle, etc., have been that of geometricians: and as those who pretend to have discovered the solution of the latter problems are in general persons scarcely acquainted with the principles of geometry, those who search for, or imagine they have found, the perpetual motion, are always men to whom the most certain and invariable truths of mechanics are unknown.

It may be demonstrated, indeed, to all those capable of reasoning in a sound manner on those sciences, that a perpetual motion is impossible: for, to be possible, it is necessary that the effect should become alternately the cause, and the cause the effect. It would be necessary, for example, that a weight raised to a certain height by another weight, should in its turn raise the second weight to the height from which it descended. But, according to the laws of motion, all that a descending weight could do, in the most perfect machine which the mind can conceive, is to raise another in the same time to a height reciprocally proportional to its mass. But it is impossible to construct a machine in which there shall be neither friction nor the resistance of some medium to be overcome; consequently at each alternation of ascent and descent, some quantity of motion, however small, will always be lost: each time, therefore, the weight to be raised will ascend to a less height; and the motion will gradually slacken, and at length cease entirely.

*Fig. U)*

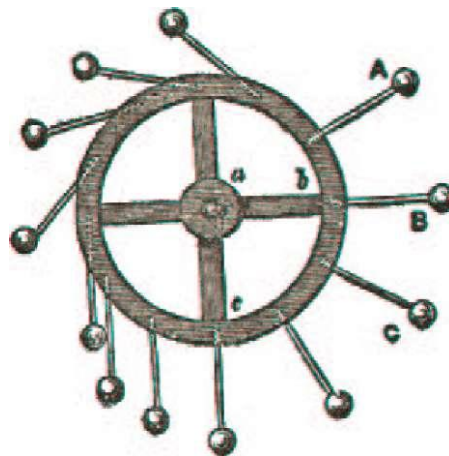

A moving principle has been sought for, but without success, in the magnet, in the gravity of the atmosphere, and in the elasticity of bodies. If a magnet be disposed in such a manner as to facilitate the ascension of a weight, it will afterwards oppose its descent. Springs, after being unbent, require to be bent by a new force equal to that which they exercise; and the gravity of the atmosphere, after forcing one side of the machine to the lowest point, must be itself raised again, like any other weight, in order to continue its action.

We shall, however, give an account of various attempts to obtain a perpetual motion, because they may serve to show how much some persons have suffered themselves to be deceived on this subject.

*(Fig. 63.)*

Fig. 52, plate 12, represents a large wheel, the circumference of which is furnished, at equal distances, with levers, each bearing at its extremity a weight, and movable on a hinge, so that in one direction they can rest upon the circumference, while on the opposite side, being carried away by the weight at the extremity, they are obliged to arrange themselves in the direction of the radius continued. This being supposed, it is evident that when the wheel turns in the direction *a b c*, the weights *A B* and *C* will recede from the centre; consequently, as they act with more force, they will carry the wheel towards that side; and as a new lever will be thrown out, in proportion as the wheel revolves, it thence follows, say they, that the wheel will continue to move in the same direction. But, notwithstanding the specious appearance of this reasoning, experience has proved that the machine will not go; and it may indeed be demonstrated that there is a certain position in which the centre of gravity of all these weights is in the vertical plane passing through the point of suspension, and that therefore it must stop.

The case is the same with the following machine, which it would appear ought to move also incessantly. In a cylindric drum, in perfect equilibrium on its axis, are formed channels as seen in Fig. 53, which contain balls of lead, or a certain quantity of quicksilver. In consequence of this disposition, the balls or quicksilver must, on the one side, ascend by approaching the centre; and on the other must roll towards the circumference. The machine then ought to turn incessantly towards that side.

A third machine of this kind is represented in Fig. 54. It consists of a kind of wheel formed of six or eight arms, proceeding from a centre, where the axis of motion is placed. Each of these arms is furnished with a receptacle in the form of a pair of bellows, but those on the opposite arms stand in contrary directions, as seen in the figure. The movable top of each receptacle has affixed to it a weight, which shuts it in one situation and opens it in the other. In the last place, the bellows of the opposite arms have a communication by means of a canal, and one of them is filled with quicksilver.

These things being supposed, it is visible, that the bellows on the one side must open, and those on the other must shut; consequently the mercury will pass from the latter into the former, while the contrary will be the case on the opposite side,

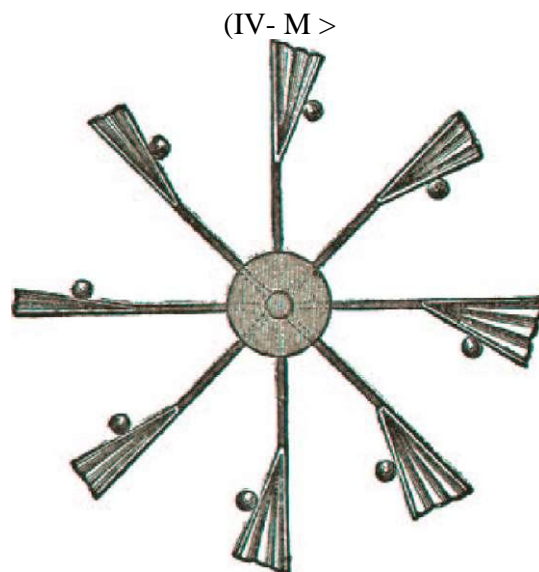

It might be difficult to point out the deficiency of this reasoning; but those acquainted with the true principles of mechanics will not hesitate to bet a hundred to one that the machine, when constructed, will not answer the intended purpose.

The description of a pretended perpetual motion, in which bellows, to be alternately filled with and emptied of quicksilver, were employed, may be seen in the "Journal des Savans" for 1685. It was refuted by Bernoulli and some others, and it gave rise to a long dispute. The best method which the inventor could have employed to defend his invention would have been to construct it, and show it in motion; but this was never done.

We shall here add another curious anecdote on this subject. One Orffyreus announced, at Leipsic, in the year 1717, a perpetual motion, consisting of a wheel which would continually revolve. This machine was constructed for the Landgrave of Hesse Cassel, who caused it to be shut up in a place of safety, and the door to be sealed with his own seal. At the end of forty days, the door was opened, and the machine was found in motion. This, however, affords no proof in favor of a perpetual motion; for as clocks can be made to go a year without being wound up, Orffyreus's wheel might easily go forty days, and even more.

The result of this pretended discovery is not known. We are informed that an Englishman offered 80,000 crowns for this machine; but Orffyreus refused to sell it at that price: in this he certainly acted wrong, as there is reason to think he obtained by his invention, neither money, nor even the honor of having discovered the perpetual motion.

The Academy of Painting at Paris possessed a clock which had no need of being wound up, and which might be considered as a perpetual motion, though it was not so. But this requires some explanation. The ingenious author of this clock employed the variations in the state of the atmosphere for winding up his moving weight. Various artifices might be devised for this purpose; but this is no more a perpetual motion than if the flux and reflux of the sea were employed to keep the machine continually going; for this principle of motion is exterior to the machine, and forms no part of it.

But enough has been said on this chimera of mechanics. We sincerely hope that none of our readers will ever lose themselves in the ridiculous and unfortunate labyrinth of such a research. To conclude, it is false that any reward has been promised by the European Powers to the person who shall discover the perpetual motion; and the case is the same in regard to the quadrature of the circle. It is this idea, no doubt, that excites so many to attempt the solution of these problems; and it is proper they should be undeceived"

The foregoing, we believe, are sufficient to disclose the gist of all that is known, and all that has been said concerning the claimed inventions of the distinguished Marquis and the distinguished Councillor. It is manifest from reading the above that Dircks himself, as well as nearly all the other eminent persons quoted above, felt an extreme delicacy in stating their honest belief concerning the claims of the distinguished inventors. That delicacy arose from their deference to the rank and prominence of the Marquis and the Councillor. The author of this book is not thus encumbered, and has no such regard for family or official rank, and feels at liberty to say exactly what he thinks.

No one now actually believes that either the Marquis or the Councillor ever made a wheel or machine that actually furnished its own motive- power. Those who believe in the impossibility of Perpetual Motion, of course, do not admit the possibility of such a thing. Those who may still believe in the possibility of Perpetual Motion devices admit, as they must, that had either of these discoveries actually been made it would have supplanted steam, electricity, wind, water and all other forms of power for driving machinery, and, indeed, for furnishing heat. And, yet, the above articles and comments show that the contemporaries of the Marquis and the Councillor, and subsequent writers on their claims sought to find excuses and explanations consistent with their good faith and their claims. We do not accuse either one of them of vicious falsehood, but the truth is that when the Marquis of Worcester wrote that "all the weights of the descending side of a wheel

shall be perpetually farther from the centre than those of the mounting side, and yet equal in number and heft to the one side as the other. A most incredible thing, if not seen; but tried before the late King (of blessed memory) in the Tower by my directions," etc., he meant, if he meant anything, to convey the idea that he had constructed such a machine, and had exhibited it before King Charles I, and when Orffyreus wrote "The inward structure of the wheel is of a nature according to the laws of mechanical perpetual motion, so arranged that by disposed weights once in rotation they gain force from their own swinging and must continue their movement as long as their structure does not lose its position and arrangement," he meant, as clearly appears from the entire context of what he wrote, to convey the idea that he had constructed a wheel capable of moving perpetually by virtue of the arrangement of its own parts until it should wear out. Neither one spoke the truth. Each knew that he had done no such thing as he claimed to have done. He probably thought the solution so near at hand that he could safely announce it to the world, and when called upon for a demonstration could produce the finished working article.

The author of this book has known many Perpetual Motion workers so confident and so enthusiastic that unhampered with extreme discretion, they announced that they were near enough to the solution of this ages- old puzzle that they were certain of success. A little less discretion, with the slightest disregard or even carelessness about the absolute truth could have easily led them to announce that they had such a working machine. The author has indeed known a few such announcements. It is therefore, not surprising that in the history of Perpetual Motion labors, instances can be found where the tireless, but enthusiastic worker being full of confidence, and not secretive, and with the least bit of human carelessness about the truth have announced the actual discovery and successful operation of the machine. We will undertake to say that there have been thousands of just such instances during the last three or four centuries, probably tens of thousands. It is probable that such an instance could be found in every township in the United States. It is not, therefore, surprising that two instances can be found in persons of sufficient personal eminence to give credence and weight to their stories. Such we conceive the facts with reference to the Marquis and the Councillor. Each thought what he told when telling it to be a harmless stretch of the truth, and felt sure that he could protect himself by a very little added perfection to his device. How many many Perpetual Motion devices have been perfect and ready for successful operation except for "one little thing," which the inventor felt sure of finding.

The Marquis and Councillor by their little indiscretion, and their puerile carelessness about the truth, each made himself neither famous, nor infamous, but ridiculous in history.

## Chapter XI

### **Conservation of Energy A Discussion of the Relation of the Doctrine of Conservation of Energy, and the Possibility of Perpetual Motion**

*Conservation of Energy* is a doctrine to the effect that energy, like matter, is indestructible, and, except by the infinite, can neither be created nor destroyed; that the sum total of all Energy in the world remains constant; that it may manifest itself in different forms, as heat, magnetism, electricity, mechanical motion, vaporization, but that the sum total remains the same.

Nothing could be more satisfactorily proved than this doctrine, and, yet, like Newton's theory of universal gravitation the proof does not amount to a mathematical demonstration. Mathematics demonstrates the conformity of the doctrine of universal gravitation, and of Conservation of Energy with all known natural processes and observed phenomena; but mathematics does not otherwise prove the Universality of Gravitation nor Conservation of Energy.

Writing on this subject of proof, with reference to gravitation, the late and eminent Simon Newcomb says:

"It may be inquired, is the induction which supposes gravitation universal so complete as to be entirely beyond doubt? We reply that within the solar system it certainly is. The laws of motion as established by observation and experiment at the surface of the earth must be considered as mathematically certain. Now, it is an observed fact that the planets in their motion deviate from straight lines in a certain way. By the first law of motion, such deviation can be produced only by a force; and the direction and intensity of this force admit of being calculated once that the motion is determined. When thus calculated, it is found to be exactly represented by one great force constantly directed toward the sun, and smaller subsidiary forces directed toward the several planets. Therefore, no fact in nature is more firmly established than is that of universal gravitation, as laid down by Newton, at least within the solar system."

It will thus be observed that the theory of Universal Gravitation is not by scientific men claimed to have been mathematically demonstrated, but its proof is regarded as resting upon its conformity with known natural phenomena. The same thing is true of Conservation of Energy. Scientists and mathematicians do not claim proof of this doctrine other than by its universal coincidence with all natural manifestations, and, yet its proof rests upon such a solid structure of coincidence and conformity with all known things in nature, that now all scientific research begins with its assumption, and with the exclusion of the possibility of Perpetual Motion.

It is not within the purview of this work to give a history of the origin and establishment in science of the doctrine. While, as heretofore noted in this book, a number of scientists of the past few centuries are shown by their reflections to have had a measure of appreciation of its ultimate effect, and to have applied that effect in their scientific researches,<sup>127</sup> there is no evidence that they ever dreamed of its establishment as a basic fact of science. The real establishment and acceptance of the doctrine dates not much over a half century back. Since that time many scientists have in their researches and writings contributed to its evolution and formation. The experiments of Joule, of England, and the generalizations of Helmholtz, of Germany, are entitled to special mention.

Scientists are naturally and necessarily conservative. So many startling pseudo-scientific facts are announced, that every startling scientific theory, before it is accepted, is submitted to the most

careful and crucial tests. No modern scientist will announce a scientific fact as having been demonstrated until the demonstration is complete and fortified with repeated tests of mathematical rigidity, and as long as there remains a phenomenon that does not conform to the supposed theory, acceptance and promulgation will be withheld. It is, therefore, not surprising that the doctrine of Conservation of Energy has been thoroughly entrenched as an established indisputable and accepted fact of science, less than a single generation.

The student of natural science should be warned against the common error of supposing that the discovery of a scientific fact or theory, means demolition of the old theories. The rule is the other way. New theories are additional information to the world, and usually conform to, and are built upon what was known before. Conservation of Energy was generalized from previously known facts conformed to them and reflexively elucidated them, and left them standing clearer than before.

The proof that Conservation of Energy conforms to all other known phenomena of nature has been aided, and hastened by the refinement of scientific instruments by which forms of energy such as heat, electricity, and magnetism can be more delicately measured and determined than ever before, and if instruments for measuring and determining the amount of energy in its various forms were as crude as they were even a single century ago, it is probable Conservation of Energy would still be the undiscovered foundation of all natural phenomena.

Let us now consider a few well-known facts which it has been determined positively by the most delicate instruments, prove and illustrate the doctrine of Conservation of Energy.

Resistance to motion, or which is the same thing, motion against resistance, is always accompanied by heat. This developed heat is not always readily perceptible to our sense of touch. A stone, ball or other object thrown through the air has its motion gradually arrested by the air. Heat is developed, but the heat is distributed through so much air and the object thrown is heated so little that this development of heat was not known until scientifically discovered. Where the resistance is friction, the development of heat is quite perceptible, and has always been well known. Suppose a coin be rubbed on a cloth or blotter. Heat is developed both in the coin and the blotter the more vigorous the rubbing i. e., the more energy expended, the greater the heat. Science has determined that the developed heat is exactly proportional to the expended energy. Every machinist knows that in turning a tap on a bolt where the threads are rusty so that it turns only with the application of great force, a considerable amount of heat is readily developed. The heat developed is proportional to the energy expended in turning the tap.

A wheel revolving on a spindle will develop heat exactly proportional to the resistance the spindle offers to the wheel turning upon it. Thus, we often see smoke and a blaze rising from the spindles of the car wheels where oil is lacking, and they turn with difficulty.

Every farmer knows that if a buggy wheel turns with difficulty for want of lubrication, or for any other reason, the spindle will heat, expand and lock the wheel, so that it will often either grind out the boxing or slide on the ground. Whereas, if the parts be kept lubricated so that less energy is required to turn the wheel on the spindle, there is no perceptible heat developed, but in all cases heat is developed to some extent, and the heat developed is exactly proportional to the energy necessary to force the revolution.

With heat we can boil water and make steam under a pressure, and with the steam under a pressure we can run an engine, and with the engine make heat by friction, or make electric current that can produce heat. Carry this proposition back to the fuel box, and knowing the amount of heat developed by the burning of a certain quantity of fuel, it is found that, counting the heat that rises in the air through the smoke stack, the heat that is radiated from the boiler, the heat that is carried away in warmed ashes, the heat that exists in the steam after it is exhausted from the cylinder, and

all other heat expended whether utilized in driving the machinery or going to waste, the sum total is in every case equal to the heat developed by the fuel box combustion. The most striking thing about all this is that when the steam goes into the cylinder where it is cooled as it expands and drives the pistons, the heat *thus lost by the expanding steam is the exact equivalent of the mechanical energy realised against the piston head*. Not all of the energy that is realized at the piston head is delivered to the driving shaft. Some of it is lost in the friction of the piston rings wearing against the cylinder lining; some, of course, is lost in friction at the journals connecting with the driving shaft. It is usual in counting engine efficiency to count the amount of energy delivered to the belt, or to the driving shaft, and because of the frictional resistance of the pistons working in the cylinder, there is always found a little discrepancy between the energy represented by the cooling of the steam in the cylinder and the energy delivered to the belt, or the driving shaft.

It is quite surprising how much energy a small amount of heat represents if it could all be converted into the obvious forms of energy. Owing to the great waste suffered in all modern machinery, heat represents much more energy than is ordinarily supposed, in the absence of exact knowledge. One would hardly think it possible that the amount of heat that will raise the temperature of one pound (almost exactly one pint) of water, one single degree (Fahrenheit) is the equivalent of energy required to elevate one pound seven hundred seventy-eight feet high against the force of gravity. Yet, such is the case. This was one of the demonstrations of the immortal Joule. It was he who enabled us to cross the bridge with calculations from mechanical force and motion to heat. He stated the equivalent to be seven hundred seventy-two feet, but more delicate instruments than could be had in his day have shown a slight discrepancy in his calculations, and it is now known to be almost exactly seven hundred seventy-eight feet. Thus, if the Falls of Niagara be considered as being one hundred sixty feet high, the energy developed by the descent is only the equivalent of the heat necessary to raise the temperature of the water about one-fifth of one degree. A modern railroad locomotive does well to realize to the driving rod two per cent of the total energy developed in the fuel box. An ordinary thrasher engine realizes no more than one per cent. The very best steam engines known in large stationary plants do not realize as much as fifteen per cent. The amount of heat necessary to raise the temperature of one pound of water one degree is taken as a standard for heat measurement, and is known as a British Thermal Unit nearly always in scientific works abbreviated to B. T. U. The common standard of energy is the amount of energy or work necessary to elevate one pound one foot against the force of gravity. This in scientific works is usually referred to as the foot-pound.

From what is said above it is manifest that one B. T. U. is the equivalent of seven hundred seventy-eight foot-pounds, and vice versa.

The *amount* of energy must not be confused with the rate of expending energy, or doing work. The horse-power is the common measurement of the rate of delivery of energy or of doing work and is equivalent to 33,000 foot-pounds per minute. It is what one horse can do, and continue doing several hours with reasonable ease. For a short time a horse can exert several horsepower.

Remember, and remember always that heat and electricity are just as much forms of energy as the motion of concrete objects.

We have introduced the above statement of equivalents for the purpose of enabling us to present a few fundamental facts more clearly than could otherwise be done.

Everyone knows that if paddles be revolved rapidly in a vessel containing a liquid, such as a churn, or the like, the liquid will offer considerable resistance to their motion, the amount of resistance depending upon the nature of the liquid, and the rapidity of the motion.

Our scientific instruments have determined the fact to be that the B. T. U. developed in the liquid and on the paddles is the exact equivalent to the foot-pounds of energy required to drive the paddles, i. e., the number of B. T. U. is 778 times the number of foot-pounds.

An engine is run with steam the engine drives an electric generator. Electricity is developed. This electricity is conducted over a wire to a motor. It is always found that not as much energy can be derived from the motor as is supplied from the generator to the wire. Where is the loss?

It is found that the loss is in the resistance of the wire to the current, and that the wire is warmed possibly not sufficient to be perceptible to the ordinary sense of touch, and, yet, it is warmed to some extent, and the B. T. U., developed in, and radiated away by the wire, amounts precisely and exactly to the difference in footpounds between the energy supplied to the wire at one end of the wire, and the energy supplied by the wire at its other end.

Capillary Attraction is one form of motion by which liquids are elevated and carried considerable distance. The moisture is taken from the earth and carried up the trunks of trees, and out through their limbs to their leaves. This cannot be done without force and energy, but where is the heat? It has been determined and proven that there is an expenditure of heat in doing that work, and that the expenditure of heat is precisely equivalent to the work done. It is hardly believable that there is a loss of heat by coal oil or water, or other liquid performing the work of ascending the wick, and yet, science has determined that that work is only done at the expense of that other form of energy—heat.

If an object falls a distance of twenty feet, and it strikes one end of a lever having two arms of equal length, and at the other end of the lever there be a ball of equal weight, the other ball will be thrown upward twenty feet, less an allowance for the resistance of the air in the descent and ascent, and for the frictional resistance of the motion of the lever. It would throw a ball of twice the weight half the height by adjusting the levers properly. Or, it would throw a ball of one-third the weight three times as high, and soon.

A ball rolling down an inclined plane is found to have a velocity, and consequently a striking force, and an energy equal to that acquired in falling the vertical distance of its descent, due allowance being made for the resistance offered to its rolling motion. It makes no difference whether the incline be great or small, the velocity, the energy are the same as though it had fallen perpendicularly through the same vertical distance.

Instances and illustrations can be multiplied indefinitely. Millions of tests have been made by scientific men, and the basic fact of Conservation of Energy is found true everywhere. That fact is that energy cannot be created. So much as is given is returned in some other form, or else in the form of heat, but in some form, precisely the equivalent is always found to exist.

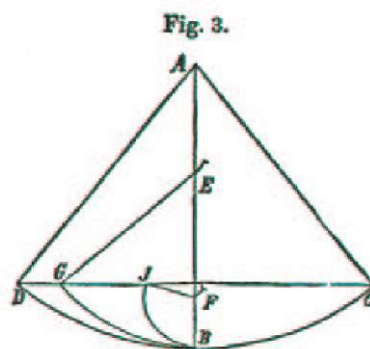

One of the most beautiful experiments is with the pendulum. Imagine a nail or peg driven into a wall and projecting out say six inches from the wall. Hang a pendulum four feet long let the

pendulum swing parallel to the wall in the annexed figure. Let "A" represent the point from which the pendulum is suspended. Draw the pendulum back to C, and release it. Its lowest descent in the swing will be at B. It will swing to D, and a line connecting D & C is exactly horizontal, showing that the energy represented by the motion of the pendulum at B was sufficient to elevate it to the point D. Now, on a line on the wall downward from where the nail or peg is driven into the wall, let there be made holes into which a nail or peg can be inserted, and suppose a peg be driven at the point F. If now pendulum be released at C, it will be found that when the cord strikes F the pendulum will swing to the point J, which is on the horizontal line D C. It makes no difference where the interrupting peg or nail be placed, the pendulum will rise to the same horizontal form which

it was released. It is said that this was one of Gallileo's experiments. If so, it is another example of the masterly force and originality of his genius, and shows that he subconsciously had some appreciation of the basic facts of the now accepted doctrine of Conservation of Energy.

We believe it is useless to multiply instances further, to illustrate the doctrine of Conservation of Energy, and show the character of proof upon which it rests. There is no fact in nature, but what in the hands of modern science appears to conform to this doctrine. A few years ago when radio-active properties were first discovered it was thought that it was an exception, but even that has been found to conform to this wonderful generalized doctrine.

If the doctrine of Conservation of Energy be true about which there seems to be no doubt, then all hopes of ever attaining Perpetual Motion must cease, for the idea of Perpetual Motion is predicated and has its foundation upon the creation of energy. The mechanism must give more energy than is imparted to it. It must make energy, and this in the light of the generalized truth of Conservation of Energy is an impossibility. We might as well talk about making substance, and the creation of substance, or the creation of energy either one is not an attribute of man. It is an attribute to be accredited only to the infinite, and can not be conceived as an attribute of the finite.

## Chapter XII

### Will Perpetual Motion Ever Be Accomplished?

The antiquity of the problem of Perpetual Motion, and the countless attempts by clever and ingenious minds to accomplish its solution, and the uniform failure of such attempts is no proof at all, scientifically speaking, that Perpetual Motion is an impossibility. If there be scientific proof that Perpetual Motion is unattainable, that proof must be found elsewhere than in the number of attempts and the universality of failures, or in the number or eminence of the people who believe it to be impossible.

Dircks in his work printed in 1861, being "A History of the Search for Self-Motive Power, During the 17th 18th and 19th Centuries," says on the subject:

"The subject of Perpetual Motion opposes paradox to paradox. It is viewed both as being most simple and most difficult to find. The learned justify both its possibility and impossibility. Many mechanics believe it possible \* \* \* Its pursuit always commences in confidence, only to end in doubt. \* \* \*

We think a careful perusal of all that has been gathered respecting Perpetual Motion clearly establishes that much remains to be done to prove the impossibility of practically solving this knotty problem; and that a full demonstration of the difficulties that environ it is worthy of being attempted, even by the most exalted mathematicians. It is not requisite that they should descend to the level of the most ordinary minds, but leave it for others to reduce their elaborated reasonings on the subject to some generally comprehensible form. We fear the proposal partakes too much of the difficulty of proving a negative; but still, as the attempt has been made by celebrated savants, and is generally considered insufficient; and as data may have been wanting, which we conceive a collection of the chief known examples will supply; we recommend the consideration of this matter to all geometers.\* \* \*

In a mathematical point of view, we think this subject is far from being exhausted; and, after what has been advanced, may very properly be considered as claiming grave considerations. And that, scientifically examined, it is a mark of mere shallowness and querulousness to attempt the substitution of ridicule and satire for the more difficult, but consistent course of sound, close reason and argument, such as the wonted sobriety and severity of scientific criticism accords to its investigations generally."

At the time of the publication of Dircks's work from which the above quotation is taken (1861), the doctrine of Conservation of Energy had not been announced and accepted as an established generalization of a scientific fact, and it is apparent was not understood by him. Dircks's statement "as data may have been wanting, which we conceive a collection of the chief known examples will supply," shows that he misconceived the nature of the problem of proving the impossibility of Perpetual Motion. If, however, the principle of Conservation of Energy is a true scientific fact, the impossibility of selfmotive power follows as an inevitable scientific corollary, and the ignis fatuus hope of attaining Perpetual Motion which has deluded so many bright minds is forever destroyed and demolished.

A perusal of the arguments against Perpetual Motion made by thinking men with scientific minds even though long before the thorough establishment of the doctrine of transmutation and

Conservation of Energy, discloses the fact that those arguments in fact depend finally on the principle now known and designated Conservation of Energy.

It is amusing to note in reading the arguments on the subject by our greatest philosophers, Newton, Gallileo, Huyghens, and Descartes, that while they lived and labored long before Conservation of Energy in its generalized form was known, or announced, they seemed to have a perception that energy could not be created; that energy must produce an effect commensurate with its own activity; that the existence of energy in one body is proof positive that some agency furnished and lost an exact equivalent of that energy. In other words, these men in reasoning on specific problems presented to them, and on the problem of Perpetual Motion in particular, appear to have appreciated and applied in their reasonings, the principle of Conservation of Energy.

Men who have worked at the problem of Perpetual Motion before the establishment of the doctrine of Conservation of Energy, and men who still work at the problem, who, through lack of opportunity have not become familiar with that doctrine, are not to be blamed or thought stupid because of that folly, but those who knowing that principle, or being in a situation to know it, must be mechanically and mathematically stupid not to realize that Perpetual Motion and Conservation of Energy are irreconcilable, and that both cannot be possibilities. In this day when the principle of Conservation of Energy is taught in the High Schools of the United States, and in every other civilized country in the world, it is not surprising that fewer people work on Perpetual Motion than formerly, and that public interest in the subject is waning, as waning it surely is.

A generation ago, however, this principle was not known and taught, and the state of the world's learning was at such a stage that many even scientific minds thought Perpetual Motion possible, and worked for its attainment.

The principle of Conservation of Energy as applied to all Perpetual Motion devices can be stated as follows: There can be no mechanical effect without an equal mechanical cause. Energy—i. e., the capacity to do work, can only be imparted by an equal amount of work done. It therefore follows axiomatically that Perpetual Motion is possible only if and when a machine be produced that runs absolutely without friction and absolutely without atmospheric resistance, or the resistance of bending of cords, or other like mechanical resistance. If there be such resistance, then the energy imparted to the machine will be diminished by that resistance, with the result that the machine can only yield the amount of energy imparted, less the energy required to overcome such resistance. That no machine can be built free of such resistance is patent to even a tyro in mechanics.

It will be interesting here, and perhaps more interesting than useful, to add some of the arguments quoted by Dircks and reproduced in his work for and against the possibility of Perpetual Motion. They have little scientific value at this time, as they were all made by men who were unfamiliar with the decisive principle of Conservation of Energy. Nevertheless, for their historical interest we offer a few:

### The Possibility of Perpetual Motion Denied Remarks of Dr. Papin on a French Contrivance

In 1665, Dr. Papin, Fellow of the Royal Society, brought before the Royal Society of London, a paper concerning a French contrivance for Perpetual Motion. The following excerpt will illustrate and explain the contrivance: The paper printed in French, and containing contrivance for perpetual motion, being set down in such a manner that can hardly be understood but by those that are much acquainted with such descriptions, I have endeavored to explain it as follows:

Let D E F be a pair of bellows forty inches long, that may be opened by removing the part F from E; let them be exactly shut everywhere but at the aperture E; and let a pipe E G, twenty or twenty-two inches long, be soldered to the said aperture E, having its other end in a vessel G, full of mercury, and placed near the middle of the bellows.

A is an axis for the bellows to turn upon.

B, a counterpoise fastened to the lower end of the bellows.

C, a weight with a clasp to keep the bellows

Now, if we suppose the bellows opened only to fourth, standing upright, and full of mercury, it said mercury, being forty inches high, must fall, Torricellian experiment, to the height of about inches, and, consequently, the bellows must and leave a vacuity there. This vacuity must be mercury ascending from G through the pipe G E, but twenty-two inches long; by this means the opened more and more, till the mercury ascend makes the upper part of the bellows so lower part must get loose from the clasp C, and turn quite upside down;

upright.

one-third or one-  
is plain that the  
as in the  
twenty-seven  
open towards F,  
filled with the  
the said pipe being  
bellows must be  
continuing to  
heavy that the  
the bellows should

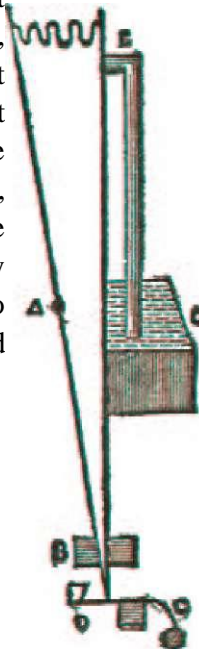

but the vessel G being set in a convenient place, keeps them horizontal, and the part F engageth there in another clasp C; then the mercury, by its weight, runs out from the bellows into the vessel G through the pipe E G, and the bellows must shut closer and closer until the part E F comes to be so light that the counterpoise B is able to make the part F get loose from the clasp C; then the bellows come to be upright again; the mercury left in them falls again to the height of twenty-seven inches, and, consequently, all the other effects will follow as we have already seen, and the motion will continue forever. Thus much for the French author.

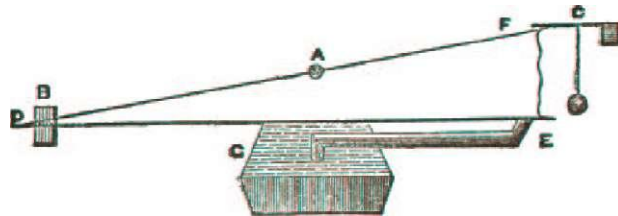

Upon this it is to be observed, that the bellows can never be opened by the internal pressure, unless the said pressure be stronger than the external; now, in this case, the weight of the atmosphere doth freely press up the outward part of the bellows, but it cannot come at the inward part but through the pipe G E, which, containing twenty-two perpendicular inches of mercury, does counterpoise so much of the weight of the atmosphere, so that this being supposed to be twenty-seven inches of mercury, it cannot press the inward part of the bellows but with weight equivalent to five perpendicular inches of mercury. From this we may conclude, that the pressure of the atmosphere, being weakened within the bellows more than it can be helped by the mercury contained in the same, as may easily be computed, the said bellows standing upright must rather shut than open. Thus, without losing any labor and charges in trying, people may be sure that the thing can never do.

### Two "Certain" Plans for (Not) Producing Perpetual Motion

In 1834, the following article was Contributed to "Mechanics' Magazine." The contributor was very frank, and presents some splendid suggestions for Perpetual Motion workers. His article is as follows:

Very few young mechanics escape being seduced into an attempt to produce a perpetual movement, by making gravitation counteract itself.

They are not contented with being told by older men, that a cause can never be made to exceed its own power; yet gravitation is expected by them to lift up on one side more weight than sinks on the other, with some percentage of friction into the bargain. Nature, however, is too true to itself to be so taken in by all or any of the multitudes of various ways the inventive genius of man has contrived, and still keeps contriving, to circumvent her immutable laws, with no other effect than to render the case so complicated as to puzzle the judgment of the inventors, which ends usually in their firm belief that they have outwitted nature instead of themselves. I acknowledge that in my youth I was one of this class, and, for the benefit of the young, I beg to present you with two *certain* plans for producing perpetual motion, and compelling gravity to be frolicsome, and do more work than she ought

Let A (Fig. 1) be a cistern full of oil or water, above 4 feet deep. Let B be a wheel; freely suspended within it, on its axle, let there be four wide glass tubes, 40 inches long, *c c c c*, having large bulbs, holding, say a pint, blown at the closed end. Fill these tubes with mercury, fix on an Indian-rubber ball or bladder, that will hold a pint, to each of them at the open end, and let them be attached round the wheel, as exhibited in the figure. As the pressure of 40 inches of mercury will exceed the

atmospheric pressure, and also that of the four-foot column of water, when the Indian-rubber bottle is lowest, and the tube erect, at at D, the mercury will fill it, leaving a vacuum in the glass bulb above. On the opposite side the mercury will fill the glass bulb, and the Indianrubber bottle will be pressed flat, as will also be the case in the two horizontal tubes. Now, it is evident that the two horizontal tubes exactly balance each other; but the tube D, with its bulb swelled out, displaces a pint of water more than its opposite tube, and hence will attempt to rise with the force of about one pound; and each tube, when it arrives at the same position, must produce the same result, the wheel must have a continual power, equal to about one pound, with a radius of two feet.—Q. E. D.

Let Fig. 2 represent a light drum of wood—one-half of which is inserted into a cleft in a water-cistern A, which fits it, and from which the water is prevented from escaping by a strip of leather, which the water presses against the drum, and which thus operates as a valve, without much friction (especially if oil be substituted for water in the cistern) . Now, as this drum is much lighter than water, it must ever attempt to swim, and thus, in perpetually rising, cause the drum to revolve forcibly round its axle.—Q. E. D.

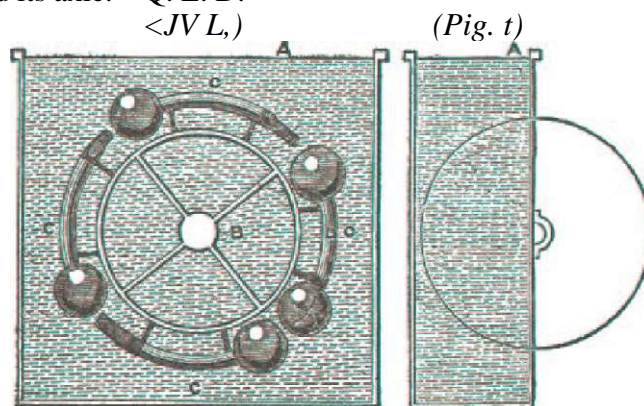

I tried this last method thirty years ago, but it was so obstinate as not to move one inch at my bidding, though it obviously is proved, to demonstration, that it ought to have gone on swimmingly. I have just heard that an Italian gentleman has hit upon the same plan; so it seems that the mania is not confined to England.

The article above quoted elicited a varied correspondence on the subject of self-motive power. The editor finally made the following apt and happy remark concerning the two "Certain" plans:

We think our correspondent, S. F., has entirely misconceived the scope of the playful account, given in our last number, of two plans of perpetual motion. The object of the writer seems to have been, to impress on the minds of young mechanics the folly of wasting their time in vain endeavors to render the effects of causes greater than the causes themselves; or, in other words, to gain power out of nothing—a process without limit or value, were it not cut short by the want of all limit to its folly; and this he could not, perhaps, have done in any way so well, as by exhibiting a couple of infallible perpetual movers that would not stir at all, though they bade as fair for it as any of their kindred.

#### Article by Rev. John Wilkins

Rev. John Wilkins of England, born 1614; died 1672, published a work called "Mathematical Magic," in which he discoursed scientifically and technically on efforts that had been made up to that time to attain Perpetual Motion. His work shows great scholarship, diligent search, and a

thorough knowledge of mathematics and mechanics. Considering the state of scientific knowledge at the time when he lived and worked, his insight into scientific subjects is truly remarkable.

Considering the state of scientific learning in his day, his observations on the subject of Perpetual Motion show him to have possessed really a great scientific and analytical mind. Of all those who wrote or thought extensively on the subject in that century we regard what he had to say as being the most worthy of reproduction. The following excerpt from "Mathematical Magic," will give the reader an idea of his course of reasoning and conclusions on the subject of self-motive power:

CHAP. IX. —*Of a Perpetual Motion—The seeming facility and real difficulty of any such contrivance The several ways whereby it hath been attempted, particularly by Chemistry.*

It is the chief inconvenience of all the automata before-mentioned, that they need a frequent repair of new strength, the causes whence their motion does proceed being subject to fail, and come to a period; and, therefore, it would be worth our enquiry to examine whether or no there may be made any such artificial contrivance, which might have the principle of moving from itself so that the present motion should constantly be the cause of that which succeeds.

This is that great secret in art which, like the Philosopher's Stone in Nature, has been the business and study of many more refined wits for divers ages together; and it may well be questioned whether either of them as yet have ever been found out; though if this have, yet like the other, it is not plainly treated of by any author.

Not but there are sundry discourses concerning this subject, but they are rather *conjectures* than *experiments*. And though many inventions in this kind may at first view bear a great show of probability, yet they will fail, being brought to trial, and will not answer in practice what they promised in speculation. Any one who has been versed in these experiments must needs acknowledge that he has been often deceived in his strongest confidence; when the imagination has contrived the whole frame of such an instrument, and conceives that the event must infallibly answer its hopes, yet then does it strangely deceive in the proof and discovers to us some defect which we did not before take notice of.

Hence it is that you shall scarce talk with any one who has never so little smattering in these arts, but he will instantly promise such a motion as being but an easy achievement, till further trial and experience has taught him the difficulty of it. There being no enquiry that does more entice with the *probability* and deceive with the *subtilty*.

I shall briefly recite the several ways whereby this has been attempted, or seems most likely to be effected, thereby to contract and facilitate the enquiries of those who are addicted to these kind of experiments; for when they know the defects of other inventions, they may the more easily avoid the same or the like in their own.

The ways whereby this has been attempted may be generally reduced to these three kinds:

1. By Chemical Extractions.
2. By Magnetical Virtues.
3. By the Natural Affection of Gravity.

1 . The discovery of this has been attempted by chemistry. Paracelsus and his followers have bragged that by their separations and extractions they can make a little world which shall have the same perpetual motions with this microcosm, with the representation of all meteors, thunder, snow, rain, the courses of the sea in its ebbs and flows, and the like. But these miraculous promises

would require as great a faith to believe them as a power to perform them; and though they often talk of such great matters:

At nusquam totos inter qui talia curant, Apparet ullus, qui re  
miracula tanta Comprobet—

yet we can never see them confirmed by any real experiment; and then, besides, every particular author in that art has such a distinct language of his own (all of them being so full of allegories and affected obscurities), that 'tis very hard for any one (unless he be thoroughly versed amongst them) to find out what they mean, much more to try it.

One of these ways (as I find it set down) is this: Mix five ounces of <sup>^</sup>with an equal weight of <sup>^</sup>grind them together with ten ounces of sublimate; dissolve them in a cellar upon some marble for the space of four days, till they become like oil olive; distil this with fire of chaff, or driving fire, and it will sublime into a dry substance; and so, by repeating of these dissolvings and distillings, there will be at length produced divers small atoms, which, being put into a glass well luted and kept dry, will have a perpetual motion.

I cannot say anything from experience against this; but I think it does not seem very probable, because things that are forced up to such vigorousness and activity as these ingredients seem to be by their frequent sublimings and distillings, are not likely to be of any duration. The more any thing is stretched beyond its usual nature, the less does it last; violence and perpetuity being no companions. And then, besides, suppose it is true, yet such a motion could not well be applied to any use, which will needs take much from the delight of it.

Amongst the chemical experiments to this purpose may be reckoned up that famous motion invented by Cornelius Dreble, and made for King James; wherein was represented the constant revolutions of the sun and moon, and that without the help either of springs or weights. Marcus Vranckhein, speaking of the means whereby it was performed, he calls it *Scintillula animae magneticae mundi, seu astralis et insensibilis spiritus*; being that grand secret for the discovery of which those dictators of philosophy, Democritus, Pythagoras, Plato, did travel unto the Gymnosophists and Indian Priests. The author himself, in his discourse upon it, does not at all reveal the way how it was performed. But there is one Thomas Tymme who was a familiar acquaintance of his, and did often pry into his works (as he professes himself), who affirms it to be done thus: By extracting a fiery spirit out of the mineral matter, joining the same with his proper air, which included in the axletree (of the first moving wheel), being hollow, carried the other wheels, making a continual rotation, except issue or vent be given in this hollow axletree, whereby the imprisoned spirit may get forth.

What strange things may be done by such extractions I know not, and, therefore, dare not condemn this relation as impossible; but I think it sounds rather like a chemical dream than a philosophical truth. It seems this imprisoned spirit is now set at liberty, or else is grown weary, for the instrument (as I have heard) has stood still for many years. It is here considerable that any force is weakest near the center of a wheel; and therefore, though such a spirit might of itself have an agitation, yet 'tis not easily conceivable how it should have strength enough to carry the wheels about with it. And then, the absurdity of the author's citing this, would make one mistrust his mistake. He urges it as a strong argument against Copernicus; as if, because Dreble did thus contrive in an engine the revolution of the heavens and the immovableness of the earth, therefore it must needs follow that 'tis the heavens which are moved, and not

the earth. If his relation were no truer than his consequence, it had not been worth the citing.

CHAP. XIII. *Concerning several attempts of contriving a Perpetual Motion, by Magnetical Virtues.*

The second way whereby the making of a perpetual motion has been attempted, is by Magnetical Virtues, which are not without some strong probabilities of proving effectual to this purpose; especially when we consider that the heavenly revolutions (being as the first pattern imitated and aimed at in these attempts) are all of them performed by the help of these qualities. This great orb of earth, and all the other planets, being but as so many magnetical globes, endowed with such various and continual motions as may be most agreeable to the purposes for which they were intended. And, therefore, most of the authors who treat concerning this invention, do agree that the likeliest way to effect it, is by these kind of qualities.

It was the opinion of Pet. Peregrinus, and there is an example pretended for it in Bettinus (apiar. 9, progym. 5, pro. 11) that a magnetical globe, or terella, being rightly placed upon its poles, would of itself have a constant rotation, like the diurnal motion of the earth. But this is commonly exploded as being against all experience.

Others think it possible so to contrive several pieces of steel and loadstone that, by their continual attraction and expulsion of one another, they may cause a perpetual revolution of a wheel. Of this opinion were Taisner, Pet. Peregrinus, and Cardan, out of Antonius de Fantis. But D. Gilbert, who was more especially versed in magnetical experiments, concludes it to be a vain and groundless fancy.

But amongst all these kinds of inventions, that is most likely, wherein a loadstone is so disposed that it shall draw unto it on a reclined plane a bullet of steel, which steel, as it ascends near to the loadstone, may be contrived to fall down through some hole in the plane, and so to return unto the place from whence at first it began to move; and, being there, the loadstone will again attract it upwards till coming to this hole, it will fall down again; and so the motion shall be perpetual, as may be more easily conceivable by this figure:

Suppose the loadstone to be represented at A B, which, though it have not strength enough to attract the bullet C directly from the ground, yet may do it by the help of the plane E F. Now, when the bullet is come to the top of this plane, its own gravity (which is supposed to exceed the strength of the loadstone) will make it fall into that hole at E; and the force it receives in this fall will carry it with such a violence unto



the other end of this arch, that it will open the passage which is there made for it, and by its return will again shut it; so that the bullet (as at the first) is in the same place whence it was attracted, and, consequently, must move perpetually.

But, however, this invention may seem to be of such strong probability, yet there are sundry particulars which may prove it insufficient; for—

1. This bullet of steel must first be touched, and have its several poles, or else there can be little or no attraction of it. Suppose C in the steel to be answerable unto A in the stone, and to B; in the attraction C D must always be directed answerable to A B', and so the motion will be more difficult; by reason there can be no rotation or turning round of the bullet, but it must slide up with the line C D, answerable to the axis A B.

2. In its fall from E to G, which is *motus elementaris*, and proceeds from its gravity, there must needs be a rotation of it; and so 'tis odds but it happens wrong in the rise, the poles in the bullet being not in the same direction to those in the magnet; and if in this reflux it should so fall out, that D should be directed towards B, there should be rather a flight than an attraction, since those two ends do repel, and not draw one another.

3. If the loadstone A B have so much strength, that it can attract the bullet in F, when it is not turned round, but does only slide upon the plane, whereas its own gravity would rowl it downwards; then it is evident the sphere of its activity and strength would be so increased when it approaches much nearer, that it would not need the assistance of the plane, but would draw it immediately to itself without that help; and so the bullet would not fall down through the hole, but ascend to the stone, and, consequently, cease its motion: for, if the loadstone be of force enough to draw the bullet on the plane, at the distance F B, then must the strength of it be sufficient to attract it immediately unto itself, when it is so much nearer as E B. And if the gravity of the bullet be supposed so much to exceed the strength of the magnet, that it cannot draw it directly when it is so near, then will it not be able to attract the bullet up the plane, when it is so much further off.

So that none of all these magnetical experiments, which have been as yet discovered, are sufficient for the effecting of a perpetual motion, though these kind of qualities seem most conducive unto it; and perhaps, hereafter, it may be contrived from them.

CHAP. XIV. *The seeming probability of effecting a Continual Motion by Solid Weights in a Hollow Wheel or Sphere.*

The third way whereby the making of a perpetual motion has been attempted is by the Natural Affection of Gravity; when the heaviness of several bodies is so contrived, that the same motion which they give in their descent, may be able to carry them up again.

But (against the possibility of any such invention) it is thus objected by Cardan:—All sublunary bodies have a direct motion either of ascent or descent; which, because it does not refer to some term, therefore cannot be perpetual, but must needs cease when it is arrived at the place unto which it naturally tends.

I answer, though this may prove that there is no natural motion of any particular heavy body which is perpetual, yet it does not hinder, but that it is possible from them to contrive such an artificial revolution as shall constantly be the cause of itself.

Those bodies which may be serviceable to this purpose are distinguishable into two kinds:

1. Solid and consistent; as weights of metal, or the like.
2. Fluid or sliding; as water, sand, etc.

Both these ways have been attempted by many, though with very little or no success. Other men's conjectures in this kind you may see set down by divers authors. It would be too tedious to repeat them over, or set forth their draughts.

I shall only mention two new ones, which (if I am not over-partial) seem altogether as probable as any of these kinds that have been yet invented; and, till experience had discovered their defect and insufficiency, I did certainly conclude them to be infallible.

The first of these contrivances was by solid weights being placed in some hollow wheel or sphere, unto which they should give a perpetual revolution; for, as the philosopher has largely proved, only a circular motion can properly be perpetual.

But, for the better conceiving of this invention, it is requisite that we rightly understand some principles in Trochilicks, or the art of wheel instruments; as, chiefly, the relation betwixt the parts of a wheel and those of a balance; the several proportions in the semi-diameter of a wheel being answerable to the sides in a balance, where the weight is multiplied according to its distance from the center.

Thus, suppose the center diameter of the wheel, D into equal parts (as it is evident, according to ground, that one pound equiponderate to five because there is such a betwixt their several the center. And it is not or no these several horizontally ; for though than C, yet this does not heaviness; or though the placed much higher than at F, yet would it still weight which it had at C; plummets (as in the heavy bodies), do tend downwards by a straight line; so that their several gravities are to be measured by that part of the horizontal semi-diameter, which is directly either below or above them. Thus, when the plummet C shall be moved either to G or H, it will lose one-third of its former heaviness, and be equally ponderous as if it were placed in the balance at No 3; and if we suppose it to be situated at I or K, then the weight of it will lie wholly upon the center, and not at all conduce to the motion of the wheel on either side; so that

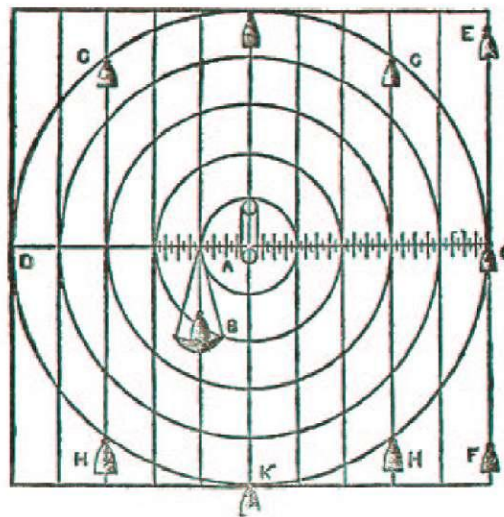

to be at A, and the C, to be divided here expressed), the former at C will pound at B, proportion distances from material whether weights be placed B do hang lower at all concern the plummet C were it is at E, or lower retain the same because these nature of all

the straight lines which pass through the divisions of the diameter may serve to measure the heaviness of any weight in its several situations.

These things thoroughly considered, it seems very possible and easy for a man to contrive the plummets of a wheel, that they may be always heavier in their fall, than in their ascent; and so, consequently, that they should give a perpetual motion to the wheel itself; since it is impossible for that to remain unmoved as long as one side in it is heavier than the other.

For the performance of this, the weights must be so ordered: 1. That in their descent they may fall from the center, and in their ascent may rise nearer to it. 2. That the fall of each plummet may begin the motion of that which should succeed it, as in the following diagram:

Where there are sixteen plummets, eight in the inward circle, and as many in the outward. (The inequality being to arise from their situation, it is therefore most convenient that the number of them be even.) The eight inward plummets are supposed to be in themselves so much heavier than the other, that in the equal weight with then the fall of these force to bring down example, if the them four ounces, be five; because the from the center five the inward is but these weights should a little string or fastened about the bullet and the center which is to fall first, other.

When these bullets, their farthest center of the wheel, then shall they be stopped, and rest on the pins

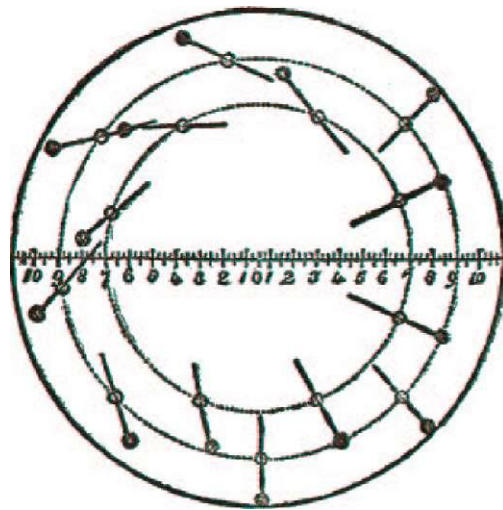

wheel they may be of those above them, and will be of sufficient the other. For outward be each of then the inward must outward is distant of those parts whereof four. Each pair of be joined together by chain, which must be middle, betwixt the of that plummet and at the top of the

in their descent, are at distance from the

placed to that purpose; and so, in their rising, there must be other pins to keep them in a convenient posture and distance from the center, lest, approaching too near unto it, they thereby become unfit to fall when they shall come to the top of the descending side.

This may be otherwise contrived with some different circumstances, but they will all redound to the same effect. By such an engine it seems very probable that a man may produce perpetual motion; the distance of the plummets from the center increasing with weight on one side, and their being tied to one another, causing a constant succession in their falling.

But now, upon experience, I have found this to be fallacious; and the reason may sufficiently appear by a calculation of the heaviness of each plummet, according to its several situation; which may easily be done by those perpendiculars that cut the diameter (as was before explained, and is here expressed in five of the plummets on the descending side). From such a calculation it will be evident, that both the sides of this wheel will equiponderate; and so consequently, that the supposed inequality whence the motion should proceed, is but imaginary and groundless. On the descending side, the heaviness of each plummet may be measured according to these numbers (supposing the diameter of the wheel to be divided into twenty parts, and each of those subdivided into four):

<i>The Outward</i>	<i>The Inward</i>
<i>Plummets</i>	<i>Plummets</i>
7.0	1.
10.      The sum 24.	0
0	7.      The sum 19.
7.0	2
On the ascending side, the weights are to be	7.      reckoned according to these degrees:
<i>The Outward</i>	<i>The Inward</i>
1.3	2
7.2	4.1
9.0      The sum 24.	7.0      The sum 19.
5.3	5.2
0.0	2.1

The sum of which last numbers is equal with the former, and therefore both the sides of such a wheel in this situation will equiponderate.

If it be objected, that the plummet A should be contrived to pull down the other at B, and then the descending side will be heavier than the other; for answer to this, it is considerable

1. That these bullets towards the top of the wheel, cannot descend till they come to a certain kind of inclination.

2. That any lower bullet hanging upon the other above it, to pull it down, must be conceived, as if the weight of it were in that point where its string touches the upper; at which point this bullet will be of less heaviness in respect of the wheel, than if it did rest in its own place; so that both the sides of it, in any kind of situation, may equiponderate.

CHAP. XV. —*Of composing, a Perpetual Motion by Fluid Weights— Concerning Archimedes his Water Screw—The great probability of accomplishing this enquiry by the help of that, with the fallibleness of it upon experiment.*

That which I shall mention as the last way, for the trial of this experiment, is by contriving it in some Water Instrument; which may seem altogether as probable and easy as any of the rest; because that element, by reason of its fluid and subtle nature (whereby, of its own accord, it searches out the lower and more narrow passages), may be most pliable to the mind of the artificer. Now, the usual means for the ascent of water is either by suckers or forces, or something equivalent thereunto; neither of which may be conveniently applied unto such a work as this, because there is. required unto each of them so much or more strength, as may be answerable to the full weight of the water that is to be drawn up; and then, besides, they move for the most part by fits and snatches, so that it is not easily conceivable, how they should conduce unto such a motion, which, by reason of its perpetuity, must be regular and equal.

But, amongst all other ways to this purpose, that invention of Archimedes is incomparably the best, which is usually called *Cochlea*, or the Water Screw; being framed by the helical revolution of a cavity about a cylinder. We have not any discourse from the author himself concerning it, nor is it certain whether he ever writ anything to this purpose; but if he did, yet, as the injury of time hath deprived us of many other of his excellents works, so likewise of this amongst the rest.

[Near five pages are occupied in describing the use of this screw, and the form and manner of making it; then follows:]

The true inclination of the screw being found, together with the certain quantity of water which every helix does contain; it is further considerable, that the water by this instrument does ascend naturally of itself, without any violence or labor; and that the heaviness of it does lie chiefly upon the centers or axis of the cylinder, both its sides being of equal weight, (said Ubaldus); so that, it should seem, though we suppose each revolution to have an equal quantity of water, yet the screw will remain with any part upwards, according as it shall be set, without turning itself either way; and, therefore, the least strength being added to either of its sides should make it descend, according to that common maxim of Archimedes any addition will make that which equiponderates with another to tend downwards.

But now, because the weight of this instrument and the water in it does lean wholly upon the axis, hence is it (said Ubaldus) that the grating and rubbing of these axes against the sockets wherein they are placed, will cause some ineptitude and resistency to that rotation of the cylinder ; which would otherwise ensue upon the addition of the least weight to any one side; but (said the same author) any power that is greater than this resistency which does arise from the axis, will serve for the turning of it round.

These things considered together, it will hence appear how a perpetual motion may seem easily contrivable. For, if there were but such a water- wheel made on this instrument, upon which the stream that is carried up may fall in its descent, it would turn the screw round, and by that means

convey as much water up as is required to move it; so that the motion must needs be continual, since the same weight which in its fall does turn the wheel is, by the turning of the wheel, carried up again.

Or, if the water, falling upon one wheel, would not be forcible enough for this effect, why then there might be two or three, or more, according as the length and elevation of the instrument will admit; by which means the weight of it may be so multiplied in the fall that it shall be equivalent to twice or thrice that quantity of water which ascends; as may be more plainly discerned by the following diagram: Where the figure L M, at the bottom, does represent a wooden cylinder with helical cavities cut in it, which at A B is supposed to be covered over with tin plates, and three water-wheels upon it, H I K; the lower cistern, which contains the water, being C D. Now, this cylinder being turned round, all the water which from the cistern ascends through it, will fall into the vessel at E, and from that vessel being conveyed upon the water-wheel H, shall consequently

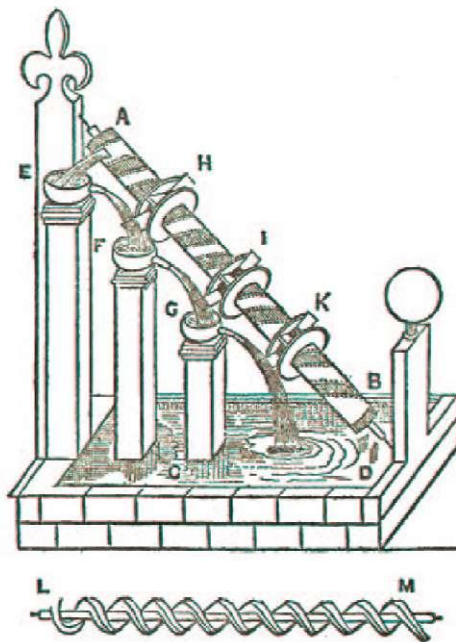

give a circular motion to the whole screw. Or, if this alone should be too weak for the turning of it, then the same water which falls from the wheel H, being received into the other vessel F, may from thence again descend on the wheel I, by which means the force of it will be doubled. And if this be yet insufficient, then may the water which falls on the second wheel I, be received into the other vessel G, and from thence again descend on the third wheel at K; and so for as many other wheels as the instrument is capable of. So that, besides the greater distance of these three streams from the center or axis by which they are made\* so much heavier, and besides that the fall of this outward water is forcible and violent, whereas the ascent of that within is natural—besides all this, there is thrice as much water to turn the screw as is carried up by it.

But, on the other side, if all the water falling upon one wheel would be able to turn it round, then half of it would serve with two wheels, and the rest may be so disposed of in the fall as to serve unto some other useful delightful ends.

When I first thought of this invention, I could scarce forbear, with Archimedes, to cry out evppKa, evppKa; it seeming so infallible a way for the effecting of a perpetual motion that nothing could be so much as probably objected against it; but, upon trial and experience, I find it altogether insufficient for any such purpose, and that for these two reasons:

1. The water that ascends will not make any. considerable stream in the fall.
2. This stream, though multiplied, will not be of force enough to turn about the screw.

1. The water ascends gently, and by intermissions; but it falls continually, and with force; each of the three vessels being supposed full at the first, that so the weight of the water in them might add the greater strength and swiftness to the streams that descend from them. Now, this swiftness of motion will cause so great a difference betwixt them that one of these little streams may spend more water in the fall than a stream six times bigger in the ascent, though we should suppose both of them to be continue; how much more, then, when as the ascending water is vented by fits and intermissions, every circumvolution voiding so much as is contained in one helix; and, in this particular, one that is not versed in these kind of experiments may be easily deceived.

But, secondly, though there were so great a disproportion, yet, notwithstanding, the force of these outward streams might well enough serve for the turning of the screw, if it were so that both its sides would equiponderate the water being in them (as Ubaldus had affirmed ). But now, upon farther examination, we shall find this assertion of his to be utterly against both reason and experience. And herein does consist the chief mistake of this contrivance; for the ascending side of the screw is made, by the water contained in it, so much heavier than the descending side, that these outward streams, thus applied, will not be of force enough to make them equiponderate, much\* less to move the whole, as may be more easily discerned by this figure:

Where A B represents a screw covered over, C D E one helix or revolution of it, C D the ascending side, E D the descending side, the point D the middle; the horizontal line C F showing how much of the helix is filled with water, viz., of the ascending side, from C the beginning of the helix, to D the middle of it; and on the descending side, from D the middle, to the point G, where the horizontal does cut the helix. Now, it is evident that this latter part, D G, is nothing near so much, and consequently not so heavy as the other, D C; and thus is it in all the other revolutions, which, as they are either more or larger, so will

the difficulty of this motion be increased. Whence it will appear that the outward streams which descend must be of so much force as to countervail all that weight whereby the ascending side in every one of these revolutions does exceed the other. And though this may be effected by making the waterwheels larger, yet then the motion will be so slow that the screw will not be able to supply the outward streams.

There is another contrivance to mentioned by Kircher depending upon the heat of the of winds; but it is liable to such exceptions that it is scarce mentioning, and does by no confidence of any ingenious Thus have I briefly explained and defects of those subtle whereby the making of a has been attempted. I would be the enquiry of any ingenious denying the possibility of any of these mechanical helps;

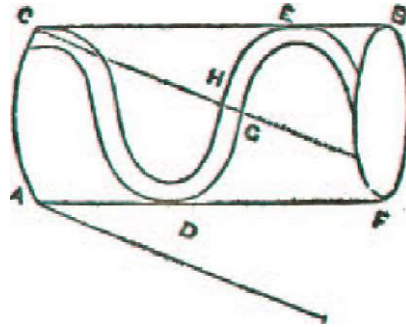

this purpose, Magnete, 1, 2, p. 4, sun and the force abundance of worth the means deserve the artist.

the probabilities contrivances perpetual motion loath to discourage artificer by effecting it with but yet (I conceive) if those principles which concern the slowness of the power in comparison to the greatness of the weight were rightly understood and thoroughly considered, they would make this experiment to seem, if not altogether impossible, yet much more difficult than otherwise, perhaps, it will appear. However, the inquiring after it cannot but deserve our endeavors, as being one of the most noble amongst all these mechanical subtilities. And, as it is in the fable of him who dug the vineyard for a hidden treasure, though he did not find the money, yet he thereby made the ground more fruitful, so, though we do not attain to the effecting of this particular, yet our searching after it may discover so many other excellent subtilities as shall abundantly recompense the labor of our inquiry.

And then, besides, it may be another encouragement to consider the pleasure of such speculations, which do ravish and sublime the thoughts with more clear angelical contentments. Archimedes was generally so taken up in the delight of these mathematical studies of this familiar siren (as Plutarch styles them) that he forgot both his meat and drink,

and other necessities of nature; nay, that he neglected the saving of his life, when that rude soldier, in the pride and haste of victory, would not give him leisure to finish his demonstration. What a ravishment was that, when, having found out the way to measure Hiero's crown, he leaped out of the bath, and (as if he were suddenly possessed) ran naked up and down, crying *evphKa, evphKa* It is storied of Thales that, in his joy and gratitude for one of these mathematical inventions, he went presently to the Temple, and there offered up a solemn sacrifice; and Pythagoras, upon the like occasion, is related to have sacrificed a hundred oxen; the justice of Providence having so contrived it, that the pleasure which there is in the success of such inventions should be proportioned to the great difficulty and labor of their inquiry.

### The Paradoxical Hydrostatic Balance

The following was contributed to an English scientific journal in 1831, the name of the author of the article is unknown to us, but here is what he wrote:

This hydrostatic balance, like the compound balance of De-saguliers, may be introduced to illustrate the impossibility of perpetual motion by a weight removed from the centre of a wheel.

Take the hollow-rimmed wheel A B; let it be air-tight and half filled with water. Let C be the axle; at B place a hollow ball loaded to a wheel, however fine its axle however well lubricated, will not revolution, though the weight B at which every deluded motionist is desirous it should be that, by such an arrangement, the another Orffyrean wheel must be

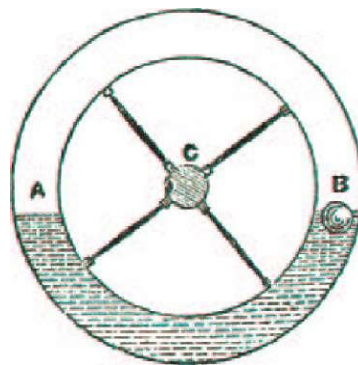

near sinking. Such may be, or make a single occupies that part perpetual-placed; concluding production of inevitable.

**Discussion by  
Fontana**

**P. Gregorio**

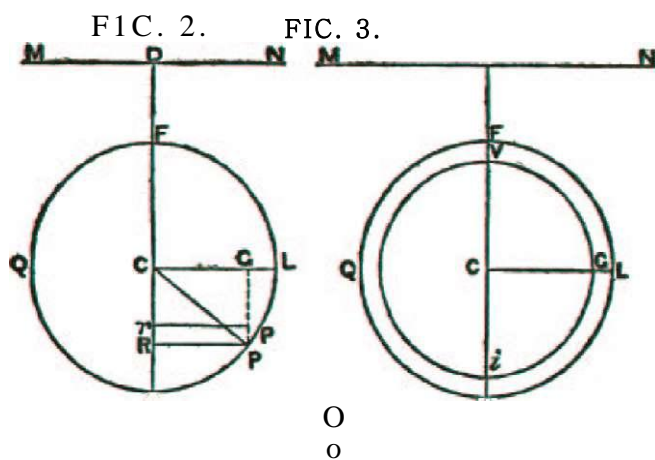

Having taken for this purpose, a part P p, and having drawn to the diameter the ordinate P. R,  $p r$ , and marked the radius P C, and from it P G perpendicular to the radius C L, which determines the quadrant O L, the distance of the lowest point O from the level of the water will be = , the

semi-diameter of the wheel =  $a$ ,  $CR = x$ , and the specific gravity of the water = 1; the perpendicular pressure against the part  $Pp = Pp \cdot RD$ , which resolved in two, one horizontal  $PR$ , the other vertical  $PG$ , gives the proportion

$$PG : PR :: Pp \cdot RD : Pp \cdot PR$$

Thence the horizontal pressure against  $Pp$ , and  $= \frac{Pp \cdot PR \cdot RD}{PR}$ , that is to say  $Pp \cdot RD$ , the given horizontal pressure is found to be  $= Rr \cdot RD = (b - x) dx$ , and which, multiplied by  $RD$ , giving  $b - x$ , becomes the momentum of the pressure relatively to  $MN = (b - x)^2 dx$ , and the sum of the momenta of pressure exercised upon the indefinite arc,  $OP$

$$= \int (b - x)^2 dx = \frac{1}{3}(b - x)^3 + \text{the side.}$$

And since acting together such momenta equal  $x$ ,

there comes the side  $= \sqrt{b^2 - (b - x)^2}$ ; and as the already-given sum of the momenta  $= \frac{1}{3}(b^2 - (b - x)^3)$ ;

$$= b^2 - bx^2 + \frac{1}{3}x^3. \text{ Whence, taking } x = 2a,$$

the sum of all the momenta of the horizontal pressure exercised on the whole semi-circumference  $OLF$  of the wheel, will be  $= 2b^2a - 4ba^2 + 3a^3$ , and dividing that sum by the whole horizontal

4 To reply adequately, it is at first necessary to know what effect is produced on the wheel by the horizontal pressure which the water exercises on the semi-circumference  $FL O$ .

$$2ba - 2a^2 \quad b - a \quad b - a \quad b - a$$

which represent the distance of the level  $MN$  from the result of all the horizontal pressure against the circumference, which distance exceeds  $DC$ , and consequently the direction of the result passes from below the centre  $C$  of the wheel to a distance from the said centre, which is

$$b - a$$

If this distance be multiplied by the result of all the horizontal pressure, that is, by  $2a \cdot (b - 2a)$ ; there is obtained  $\frac{1}{3}a^3$  for the momentum of the force which tends to make the wheel revolve from  $L$  towards  $O$ . This being established, it is known that the force which causes the half of the wheel  $FLG$  to revolve vertically to the top (calling  $g$  the specific gravity of the wheel) is  $= (1 - g) FCO L$ , and which force passes through the center of gravity of  $FL O$ . And consequently the gravity of any circular segment divided by the half of the radius, is distant from the centre of the circle by a quantity equal to the twelfth of the cube of the chord divided by the segment; and therefore the centre of gravity of the semicircle  $F C O L$ , will be distant from the centre  $C$  by the quantity

$$\frac{1}{12} \frac{Q^3}{a^3} - \frac{2}{3} a^3$$

Consequently the momentum of this force tending to make the wheel revolve from  $O$  towards  $L$  will

$$= \frac{1}{12} \frac{Q^3}{a^3} (1 - g) FCO L = \frac{1}{12} (1 - g) a^3$$

But moreover a certain momentum will be derived from the other half  $F Q O$  of the wheel, which being out of the water, tends by its own weight downwards with a force  $= g \cdot E C O Q = g \cdot E C O L$ , which multiplied by the distance

pressure, that is to say by  $f(b-x)dx = \int (b^2 - (b-x)^2) = bx - x^2 = 2ba - 2a^2$ , gives  $x = 2a$  we have the formula

$$\frac{2b^2 - 4ba + a^3}{2(b-l)^2} + \frac{b^2 - 2ba + 4a^2}{4(b-l)(a-l)^2} - a^2 + 1 a^2 \qquad 3 a^3 \text{ interior} = 2b^6 a \cdot 4ba^2 + 8a^3$$

$$- 8 (a \cdot l)^3 - 2b^2 l - 4ba l + 4a^2 l - 2a l^2 + 2 l^3 = 21 (b \cdot a) \cdot ba + 2a^2 - a l +$$

$$11^2 \\ = 21 ( (b \cdot a)(b \cdot a) + a^2 - a l + 11^2$$

Then dividing this sum of the momenta by the sum of the pressure there will be

$$211 \frac{(b-a)(b-a) + a^2 - a l + 11^2}{\dots} = + \frac{a^2 - a l + 11^2}{b-a}$$

the distance of the center of the pressure from the level of the fluid, that is, to the distance of the result of all the pressure from that level. From this it is evident that the center of pressure falls under the center of the wheel, C, to the distance

$$a^2 - a l + 11^2 b - a$$

6 say, cannot induce any motion of rotation, and both halves remain in equilibrium around the center C.

### Article by William Nicholson

William Nicholson was born in London in 1753; died in 1815. He was a scientist of note, and a writer of scientific subjects. In 1797 he established in London and continued publishing until 1814, a periodical entitled "Journal of Natural Philosophy, Chemistry and the Arts," known, however, throughout the civilized world as "Nicholson's Journal."

A Perpetual Motion device of Dr. Conradus Schwiers, in 1790, and the Richard Varley device, in 1797, described at page 132 et seq., ante, had attracted a great deal of attention, and were the occasion of much discussion. A consequent increased interest in the subject of self-moving mechanism was thus created.

Mr. Nicholson, whose scientific attainments were recognized by all, was asked to publish an article on the subject. His article appeared in his publication, "Nicholson's Journal," and is as follows:

#### *On the Mechanical Projects for Affording a Perpetual Motion*

In consequence of the notice taken of Mr. Varley's attempt to produce a perpetual motion, I have been requested by several correspondents to state how far the mechanical scheme for which Dr. Conrad Schwiers took out a patent in the year 1790, for the same object may be worthy of attention. I have, on that occasion, mentioned the difficulties which

Whence multiplying this distance by the result of the pressure, or by  $21(b - a)$ , we obtain

$$21a^2 - a^3 + 11^2$$

to express the momentum of the horizontal pressure of the water, directed to make the wheel turn from L to O.

Now the momentum with which the vertical impulse of the fluid tends to make the semi-circle F C O L turn from O to L (supposing the wheel not with a simple zone, but with a circular plane) is  $\frac{1}{2}a^3$ . Likewise the momentum of the impulse of the fluid to cause the internal semi-circle VCIG from O to L is  $\frac{1}{2}(a - 1)^3$ . Then taking this second momentum have prevented any clear general demonstration of the absurdity of this pursuit from being produced, though it has not been difficult to show the fallacy of the individual plans. It does not, indeed, seem easy to enunciate the scheme itself. What in universal terms is the thing proposed to be done? Is it to cause a body to act in such a manner that the reaction shall be greater than the action itself, and by that means generate force by the accumulation of the surplus? Or, can the motion communicated be greater than that lost by the agent? Since these positions are evidently contrary to the physical axioms called the laws of nature, and frictions and resistances would speedily destroy all motions of simple uniformity, it may be presumed that 's Gravesande, who thought that all the demonstrations of the absurdity of schemes for perpetual motion contained paralogism, would have stated the proposition under different terms. But without entering upon this apparently unprofitable disquisition, it may be useful, as well as entertaining, to make a few observations on the mechanical contrivances which depend on a mistaken deduction from the general theorem respecting the balance, among which that of Dr. Schwiers must be classed.

There is no doubt but numerous arrangements have been made, and still are labored at by various individuals, to produce a machine which shall possess the power of moving itself perpetually, notwithstanding the inevitable loss by friction and resistance of the air. Little, however, of these abortive exertions has been entered upon record. The plans of Bishop Wilkins, the Marquis of Worcester, and M. Orffyreus, are all which at this time occur to my recollection.

There is no doubt but the celebrated Wilkins was a man of learning and ability. His essay towards a real character and a philosophical language is sufficient to render his name immortal. Twenty years before the appearance of that work he published his "Mathematical Magic," namely, in the year 1648, containing 295 pages, small octavo, which, from the number of copies still in being, I suppose to have been a very popular treatise. It is in this work that I find, among other contrivances for the same purpose, a wheel carrying sixteen loaded arms, similar to that delineated in Fig. 4, plate 15, in which, however, for the sake of simplicity, I have drawn but six. Each lever, A B C D E F, is movable through an angle of 45 degrees, by a joint near the circumference of the wheel, and the inner end or tail of each is confined by two studs or pins, so that it must either lie in the direction of a radius, or else in the required position of obliquity. If the wheel be now supposed to move in the direction

Wg. \*. pt-15.)

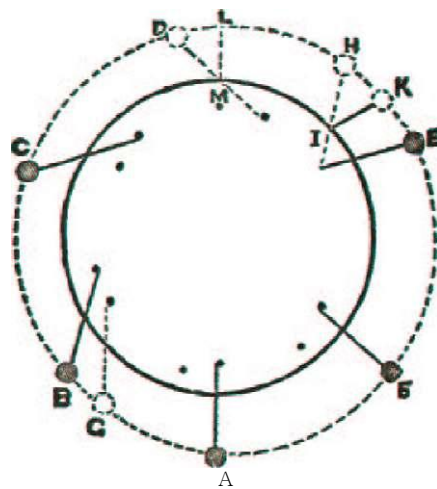

EF, it is evident that the levers AB-CD, by hanging in the oblique position against the antecedent pins, will describe a less circle in their ascent than when, on the other side, they come to descend in the positions E F. Hence, it was expected that the descending weights, having the advantage of a longer lever, would always predominate. Dr. Wilkins, by referring the weights to an horizontal diameter, has shown that in his machine they will not. A popular notion of this result may also be gathered from the figure, where there are three weights on the ascending and only two on the descending side; the obliquity of position giving an advantage in point of number, equal to what the other side may possess in intensity. Or, if this contrivance were to be strictly examined, on the supposition that the levers and weights were indefinitely numerous, the question would be determined by showing that the circular arcs A K, H I, are in equilibrio with the arcs A G, G L.

The simplest method of examining any scheme of this kind with weights, consists in inquiring whether the perpendicular ascents and descents would be performed with equal masses in equal times. If so, there will be no preponderance, and, consequently, no motion. This is clearly the case with the contrivance before us.

The Marquis of Worcester, who will ever be remembered as the inventor of the steam engine, has described a perpetual motion in the fifty-sixth number of his "Century of Inventions," published in the year 1655, and since reprinted in 1767 by the Foulis's at Glasgow. His words were as follows:

"To provide and make, that all the weights of the descending side of a wheel shall be perpetually further from the center than those of the mounting side, and yet equal in number and heft to the one side as the other. A most incredible thing if not seen, but tried before the late King (of blessed memory) in the Tower by my directions, two extraordinary ambassadors accompanying his Majesty, and the Duke of Richmond and Duke Hamilton, with most of the Court attending him. The wheel was fourteen feet over, and forty weights of fifty pounds apiece. Sir William Balfour, then Lieutenant of the Tower, can justify it with several others. They all saw that no sooner these great weights passed the diameter line of the lower side, but they hung a foot further from the center; nor no sooner passed the diameter line of the upper side, but they hung a foot nearer. Be pleased to judge the consequence."

Desaguliers, in his "Course of Experimental Philosophy," Vol. I, page 185, has quoted this passage, and given a sketch of a pretended self-moving wheel, similar to Fig. 5, plate 15, as resembling the contrivance mentioned by the Marquis of Worcester. The description of this last engineer agrees, however, somewhat better with the contrivance Fig. 4. It must, of course, be a mistake in terms, when he says the weight receded from the center at the lower diameter and approached towards it at the upper: the contrary being, in fact, necessary to afford any hope of success; and accordingly in the quotation it is so stated. I am, therefore, disposed to think that Fig. 5 represents the wheel of Orffyreus at Hesse Cassel, much talked of about the year 1720, and which probably was made to revolve, during the time of exhibition, by some concealed apparatus. It consists of a number of cells or partitions, distinguished by the letters of the alphabet, which are made between the interior and exterior surfaces of two concentric cylinders. The partitions being placed obliquely with respect to the radius, a cylindrical or spherical weight placed on each, it is seen from the figure, that these weights will lie against the inner surface of the larger cylinder whenever the outer end of the bottom partition of any cell is lowest: and, on the contrary, when that extremity is highest, the weight will rest on the surface of the interior cylinder. Let the wheel be made to revolve in the direction A B C; the weights in C D E F G H I being close to the external circle, and the weights K L M A B close to the inner, for the reasons last mentioned.

As the cell B descends, its weight will likewise run out, at the same time that the weight in the cell I will run in in consequence of its partition being elevated. By the continuation of this process, since all the weights

{Fig. 5, pi. 15.}

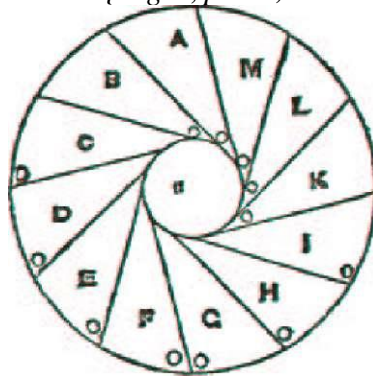

on the descending side pass down at a greater distance from the center, while those of the ascending side rise for a considerable part of their ascent at a less distance from the same point, it is concluded that the wheel will continue to maintain its motion. On this, however, it is to be remarked that the perpendicular ascent and descent are alike, both in measure and in time of performance; and that the familiar examination, even to those who know little of such subjects, is

sufficient to show that the preponderance is not quite so palpable as at first it appears. For the weights G and F, H and E, I and D are evidently in equilibrio, because at the same horizontal distance from the center; and if the favorable supposition that the weight B has already run out be admitted, it will then remain a question whether these two exterior weights, B and C, can preponderate over the four inner weights, K L M A. The more accurate examination of this particular contrivance will lead to the following theorem: In two concentric circles, if tangents be drawn at the extreme points of a diameter of the smaller, and continued till they intersect the larger, the common center of gravity of the arc of the greater circle included between the tangents and of the half periphery of the smaller circle on the opposite side of the diameter, will be the common center of the circles. If, therefore, the balls were indefinitely numerous and small, the supposed effective parts of the wheel (Fig. 5) would be in equilibrio, as well as the parts beneath the horizontal tangent of the inner circle.

Fig. 6 represents the contrivance of Dr. Schwiers, which, in a periodical publication, in other particulars respectable, has been said to continue in motion for weeks and even months together. There is not the smallest probability that it should continue in motion for half a minute, or nearly as long as a simple wheel would retain part of its first impulse. The external circle denotes a wheel carrying a number of buckets, A B I L, etc. C represents a toothed wheel, on the same axis which drives a pinion D; and this last drives another pinion E upon the axis of a lanthorn, or wheel intended to work a chainpump with the same number of buckets as in the larger wheel A B I. The lanthorn G is made of such a size as to receive the buckets *a b i l* with a due velocity. K represents a gutter through which a metallic ball, contained in the bucket m, may run and lodge itself in the bucket A of the wheel. Each of the buckets of the wheel, B I L M, which are below the gutter, is supplied with a metallic ball, and so likewise are the ascending buckets, *a b i l m*, of the chainpump. As the pump supplies the wheel, it is again supplied at M, where the balls fall into its ascending buckets. Now, it is presumed that the balls in the wheel I suppose on account of their distance from the center of motion, will descend with more than sufficient force to raise those on the chain, and, consequently, that the motion will be perpetual.

The deception in this contrivance has much less seduction than in the two foregoing, because it is more easily referred to the simple lever. This, like the others, exhibits no prospect of success, when tried by the simple consideration of the quality of the ascent and descent in the whole time of the rotation of a single ball. It may also be shown from the principles of wheel-work, which are familiar to artisans, that whatever is gained by the excess of the diameter of the great wheel beyond that of the wheel C, is again lost by the excess of the lanthorn A beyond the pinion E.

The fundamental proposition of the simple lever or balance, that equal bodies at an equal distance from the fulcrum will equiponderate, but that at unequal distances the most remote will descend, has, in these and numberless other instances, led mechanical workmen and speculators to pursue this fruitless inquiry with labor and expense often ill-afforded, and with a degree of anxiety and infatuation which can hardly be conceived by those who have never suffered the pain of hope long deferred. For this reason chiefly, it has appeared desirable and useful to treat the subject in a familiar way without descending to those expressions of contempt, which ignorance, harmless to all but itself, is surely not entitled to.

If such reasoners were well convinced that the power of a machine is to be estimated by the excess of motion referred to the perpendicular, without any regard to the apparent center of the machine, and that in machines very little compounded it is possible to produce effects di-

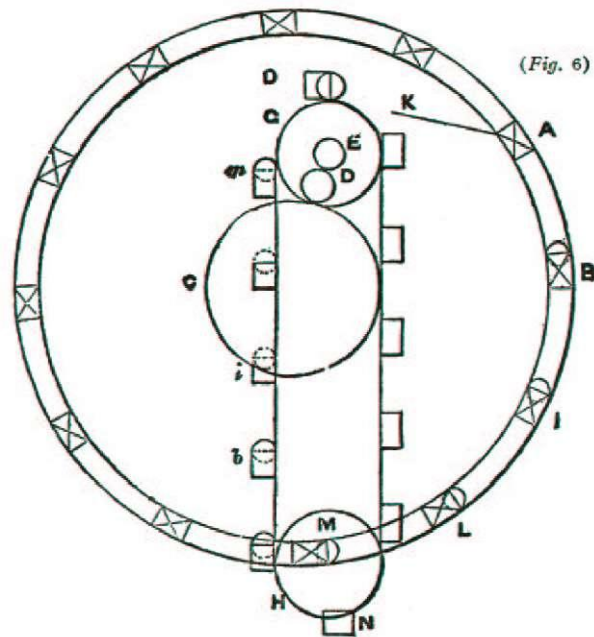

Compound Balance. (Fig. 3, pl. 15.)

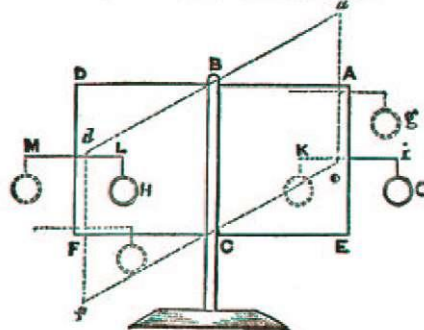

rectly contrary to the rule which is true of the simple lever, they would probably renounce many flattering projects, grounded only on the supposition of its universality. Desaguliers contrived an apparatus in which two equal weights may be placed at any distance whatever from the center of motion, and still continue in equilibrio. Fig. 3 represents this instrument. A D denotes a balance with equal arms, and E F another of the same dimensions. These move on the centers B and C, and are connected by the inflexible rods A E and D F; the motion being left free by means of joints at the corners. Across the rods A D, E F, are fixed two bars, I K, L M. Now, it is unnecessary to show that the weight G will describe exactly the same line or circular arc, when the levers are moved into the position *a d f e*, or any other position, as it would have described in case it had been suspended at A, or K, or E; and that it is of no consequence in this respect at what part of the line A E or I K it be fixed. The same observations are true of the weight H on the other side. And accordingly it is found that these equal weights may be suspended anywhere on the lines I K and L M without altering their equilibrium.

By this contrivance it is most evidently proved to those who are totally unacquainted with the theory, that weights do not perponderate in compound engines on account of their distance from the center. Several contrivances may be made to the same effect. The following combination of wheel-work presented itself to me as one which would most probably be mistaken for a perpetual motion. (Fig. 2, plate 15.) The five circles represent the same number of wheels of equal diameter and number of teeth, acting together.

The middle wheel A is fixed between two upright pillars, so that it cannot revolve. The other four wheels are pinned in a frame H I, in which they can revolve, and through which the axis of A likewise passes. From the extremity of the axis of D, and also of d, proceed the horizontal levers H K and I L, which are equal, and point in the same direction parallel to the plane of the wheels. At the extremity of these arms hang the equal weights P and p. Let it now be imagined that the end I of the frame is depressed, the wheel B will turn round by the reaction of the fixed wheel A in the same direction as H I, and it will make one revolution in the same time relative to the frame, or two with regard to absolute space, by reason of its being carried round. The action of B upon D will produce a rotation relative to the frame in the opposite direction during the same time. Instead, therefore, of two revolutions like the wheel B, this wheel D, with regard to absolute space, will not revolve at all, and

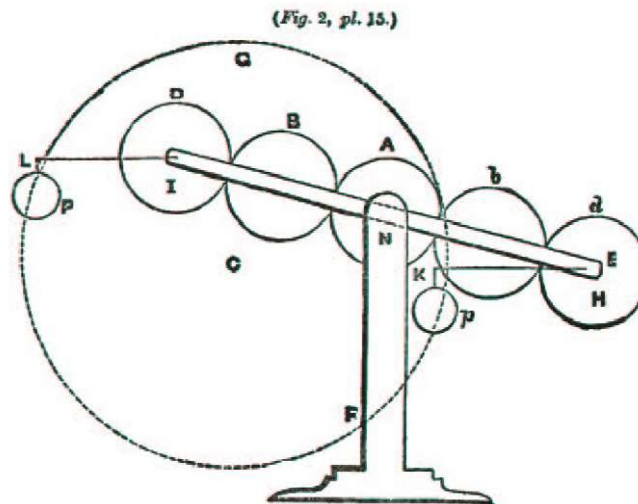

in every position of the apparatus the arm I L will continue horizontal, and point the same way. For similar reasons the arm H K will retain its position. Consequently, it is seen that the descending weight will move at a great horizontal distance from the center N, while the ascending weight rises very near that center. But there will, not on this account, be a perpetual motion: for the action of the levers H K and I L upon the frame H I, by means of the toothed wheels, will, in the detail, be found precisely alike, and in the general consideration of the motions of P and p, the opposite motions in the circle E F G will be accurately the same.

It has always been considered as essential to a perpetual motion that it should be derived from some energy which is not supposed to vary in its intensity. Such are the inertia, the gravity or magnetism of bodies. For an occasional or periodical variation of intensity in any force is evidently productive of motion, which requires only to be accumulated or applied, and the apparatus for applying it cannot be considered as a machine for perpetual motion. Neither in strictness can any machine whose motion is derived from the rotation of the earth, and the consequent change of seasons and rotation of events, be so considered, because it does not generate, but only communicates. The perpetual flow of rivers; the vicissitudes of the tides; the constant, periodical

and variable winds; the expansions and contractions of air, mercury, or other fluids, by daily or other changes of temperature; the differences of expansions in metals, by the same change; the rise and fall of the mercury in the barometer; the hygrometric changes in the remains of organized beings, and every other mutation which continually happens around us, may be applied to give motion to mills, clocks, and other engines, which may be contrived to endure as long as the apparatus retains its figure.

Mr. Nicholson's article, published above, shows, if nothing else had ever shown, the fact that he was endowed with a real scientific mind. It also shows what is still most interesting that his mind anticipated and that he had a subconscious conception of the principle of Conservation of Energy. In 1824 and 1825 there was published in London a mechanical journal called "The Artisan"; or "Mechanic's Instructor." In one of the issues the following occurred on the subject of Perpetual Motion:

Perpetual motion is a motion which is supplied and renewed from itself without the intervention of any external cause: to find a perpetual motion, or to construct a machine which shall have such a motion, is a subject which has engaged the attention of mathematicians for more than 2,000 years; though none perhaps have prosecuted it with so much zeal and hopes of ultimate success as some of the speculative philosophers of the present age.

Infinite are the schemes, designs, plans, engines, wheels, etc., to which this longed-for perpetual motion has given birth; and it would not only be endless but ridiculous to attempt to give a detail of them all, especially as none of them deserve particular mention, since they have all equally proved abortive; and it would rather partake of the nature of an affront than a compliment, to distinguish the pretenders of this discovery, as the very attempting of the thing conveys a very unfavorable idea of the mental powers of the operator.

For among all the laws of matter and motion, we know of none which seems to afford any principle or foundation for such an effect. Action and reaction are allowed to be ever equal; and a body which gives any quantity of motion to another, always loses just so much of its own; but, under the present state of things, the resistance of the air, and the friction of the parts of machines, necessarily retard every motion.

To keep the motion going on, therefore, there must either be a supply from some foreign cause, which, in a perpetual motion, is excluded.

Or, all resistance from the friction of the parts of matter must be removed; which necessarily implies a change in the nature of things.

For by the second law of motion the changes made in the motions of bodies are always proportional to the impressed moving force, and are produced in the same direction with it; no motion, then, can be communicated to any engine, greater than that of the first force impressed.

But, on our earth, all motion is performed in a resisting fluid, namely, the atmosphere, and must, therefore, of necessity, be retarded; consequently, a considerable quantity of its motion will be spent on the medium. Nor is there any engine or machine wherein all friction can be avoided; there being in nature no such thing as exact smoothness or perfect congruity; the manner of the cohesion of the parts of bodies, the small proportion which the solid matter bears to the vacuities between them, and the nature of those constituent particles not admitting it.

Friction, therefore, will also, in time, sensibly diminish the impressed or communicated force; so that a perpetual motion can never follow, unless the communicated force be so much greater than the generating force as to supply the diminution occasioned by all these causes; but the generating of motion than it had itself. Therefore, the whole affair of finding a perpetual motion comes to this, viz., to make a weight heavier than itself, or an elastic force greater than itself; or, there

must be some method of gaining a force equivalent to what is lost by the artful disposition and combination of the mechanical powers: to this last point then, all endeavors are to be directed; but how, or by what means such a force can be gained, is still a mystery!

The multiplication of powers or forces avails nothing; for what is gained in power is lost in time; so that the quantity of motion still remains the same.

The whole science of mechanics cannot really make a little power equal or superior to a larger; and wherever a less power is found in equilibrio with a greater—as, for example, twenty-five pounds with one hundred it is a kind of deception of the sense; for the equilibrium is not strictly between one hundred pounds and twentyfive pounds moving (or disposed to move) four times as fast as the one hundred pounds.

A power of ten pounds moving with ten times the velocity of one hundred pounds would have equalled the one hundred in the same manner; and the same may be said of all the possible products equal to one hundred: but there must still be one hundred pounds of power on each side, whatever way they may be taken, whether in matter or in velocity.

This is an inviolable law of nature; by which nothing is left to art, but the choice of the several combinations that may produce the same effects.

The only interest that we can take in the projects which have been tried for procuring a perpetual motion must arise from the opportunity that they afford of observing the weakness of human reason.

For a better instance of this can scarcely be supplied than to see a man spending whole years in the pursuit of an object, which a single week's application to sober philosophy would have convinced him was unattainable.

But for the satisfaction of those who may not be convinced of the impossibility of attaining this grand object, we shall add a few observations on the subject of a still more practical nature than the above. The most satisfactory confutation of the notion of the possibility of a perpetual motion is derived from the consideration of the properties of the center of gravity; it is only necessary to examine whether it will begin to descend or ascend when the machine moves, or whether it will remain at rest. If it be so placed that it must either remain at rest or ascend, it is clear, from the laws of equilibrium, that no motion derived from gravitation can take place; if it may descend, it must either continue to descend forever with a finite velocity, which is impossible, or it must first descend and then ascend with a vibratory motion, and then the case will be reducible to that of a pendulum, where it is obvious that no new motion is generated, and that the friction and resistance of the air must soon destroy the original motion.

One of the most common fallacies by which the superficial projectors of machines for obtaining a perpetual motion have been deluded, has arisen from imagining that any number of weights ascending by a certain path on one side of motion, and descending on the other at a greater distance, must cause a constant preponderance on the side of the descent; and for this purpose weights have

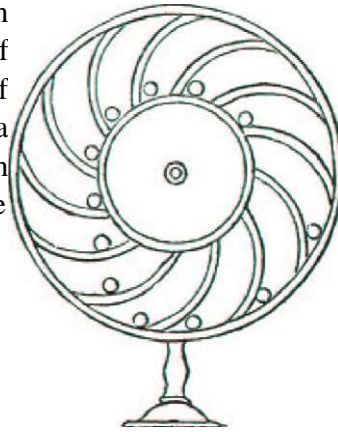

deluded, has  
weights  
the center of  
greater distance,  
the side of the

been made to slide or roll along grooves or planes, which lead them to a more remote part of the wheel, from whence they return as they ascend, as represented in the following figure: Or they have been fixed on hinges which allow them to fall over at a certain point so as to become more distant from the center; but it will appear on the inspection of such a machine that although some of the weights are more distant from the center than others, yet there is always a proportionally smaller number of them on that side on which they have the greater power; so that these circumstances precisely counterbalance each other.

We have heard it proposed to attach hollow arms to a wheel by joints or hinges at the circumference, and to fill these arms with quicksilver or small balls instead of the plan represented by the above figure; but though we have never heard of it having been tried, we are perfectly convinced that it would end as all other attempts have done; that is, in a total failure.

### **The Possibility of Perpetual Motion Asserted**

The enthusiastic earnestness with which the subject of Perpetual Motion was formerly discussed is illustrated by the fact that the Holy Scriptures were dragged in to support arguments on the proposition.

The following is a verbatim copy of an article published in an English scientific magazine in 1829: "Notice to Perpetual Motion Seekers." The following is a literal copy of a communication which we have received under this head. We publish it for the benefit of all concerned: "Perpetual Motion Seekers! see Coloss., ch. ii., v. 8— 'Beware lest any man spoil you, through philosophy and vain deceit, after the tradition of men, after the rudiments of the world/ Ye are making the words of God of none effect by your traditions in publishing these things to the world. How can such toys and baubles as these be perpetual? See Malachi. ch. iv., v. 1—'For behold the day cometh that shall burn as an oven; and all the proud, yea, all that do wickedly, shall be as stubble.' Here is the end of them. I, the undersigned, have to inform the public, the model for making perpetual motion is to be found in that too much neglected book of models, the Bible. I called upon the Lord, and he showed it to me. I said, 'Lord, shall I show this unto them? This was the answer to me: See Iraiah, ch. xli., v. 29 —'Behold, they are all vanity; their works are nothing.' I said, 'Lord, be pleased to show me some more about it.' 'Bring forth 3) that the lighter liquid, through the orifice E, will fall in the vessel below; there it again mixes with the heavier (by Hyp. 4); and then, penetrating the filter, ascends again into the tube, and escapes by the upper orifice. So, therefore, the flow is continued perpetually. Q. E. D.

### *Corollary*

Hence a reason may easily be given, why water from the depths of the ocean, ascending into the summits of the mountains, bursts from them in the form of rivers and flows again into the ocean; so does Nature offer to us the spectacle of perpetual motion.

Hence I say, they do not well explain who allege that the water ascends to these heights through the pores of the earth, as a fluid ascends in narrow tubes above the surface of the fluid surrounding; for if such were the explanation of the thing, they would never be able to demonstrate it; for the water so raised to a height from the bosom of the earth, falls again, whereas we see that the fluid in these narrow tubes, although slightly elevated above the surrounding surface, never issues from their orifices and falls into the fluid below. The following is then the more feasible explanation. It is known that water in which much salt is held in solution is heavier than fresh water; now sea-water, as is sufficiently evident from the taste, contains many saline particles; consequently it is heavier

than spring or river water; so that it is credible that the earth acts like a filter through the pores of which only fresh water can pass, the saline particles being left behind, and this increases the weight of the water; the fresh water must ascend 'much higher on account of the immense profundity of the ocean, as it is forced to the highest peaks of the mountains by the presence of the sea-water; and thence, not being able to ascend any higher, it falls in rivers.

### P. Christopher Schemer

That an earnest belief in the possibility of Perpetual Motion has not been confined entirely to scientific tyros and enthusiastic dreamers, is sufficiently attested by the fact that a respectable number of eminent scientists, many of whom had done great service in their scientific labors, have believed in such possibility.

Among these is to be mentioned P. Christopher Scheiner, a German, born 1575, and died 1650. He was a mechanic of note; in his day made valuable additions to what was known of light and optics, invented the Pantagraph, discovered solar spots, besides benefiting mankind by many other distinguished fruits of his genius.

The subject of Perpetual Motion claimed some of his attention. He wrote in defense of its possibility. The substance of what he said, translated into English, is as follows:

Let the centre of the universe then, or of gravity, be A, and the gnomon A B C, of which the extremity A is pierced and traversed by an axis going through the centre of the world, so that it may turn and revolve freely and easily around the said centre; to the other extremity of the phial full of water be attached.

The weight C will turn around the first come to D, thence to E, thence to F will return to C, having described a C D E F G; then it will again move to D, perpetually, since there is no reason for any point of the circle rather than in

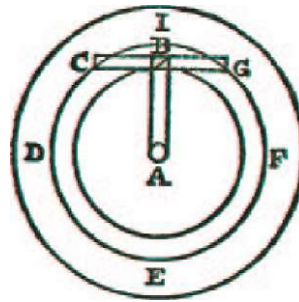

around the said gnomon, C, let a

centre A and will and G; then it complete circle, E, F, etc., and so its stopping in another.

That indeed the weight C affixed to the gnomon will move from C to D, is proved by daily experience, by which it is established that a gnomon so contrived and placed erect on any flat space, will not be able to stand, but the arm B C, C preponderating, will move towards D.

It may in the second place be proved, that if, on the other hand, another arm B G be added to the gnomon, equal in weight and similar to the other, the whole G B C A will remain motionless in equilibrium; there

fore the arm B G being taken away and equilibrium being destroyed, the arm B C must move in the opposite direction.

The above, from Scheiner, called forth the following from Schott, who was also an eminent mathematician:

Whether there could be a perpetual artificial motion around the centre of the earth?

We have treated this question in pneumatic Mechanics, Part 2, 13, not however universally, but particular case, that of the Scheiner. For P. Christopher S c "Mathematical Disquisitions," Corollary 4, asserts Perpetual not to be repugnant to Nature, prove it in the following gnomon of a certain weight A B around A, the centre of the unito the beam D F, which is columns D F and E G and turns E; or let it be fixed at the poles, revolving at A.

These being the conditions, I gnomon ABC will revolve from towards I, thence will return to C, thence to H as before, and so on perpetually. The cause of this continual motion is the forcible suspension; for the whole gnomon preponderates in C on account of the perpendicular tangent B A; which effect becomes more marked if a globe of iron S be supposed suspended at C. As therefore the whole of this mass, as well from the supports of the balance as from the momentary diameter, hangs suspended at C, and the vertex A, on account of the firm beam D E, cannot fall from the centre of the universe; it comes to pass that all points as well of the globe S, as of the gnomon ABC, with a continual motion turn round A; but because, by the line B A in the fixed point A, they are held from falling to the centre; therefore

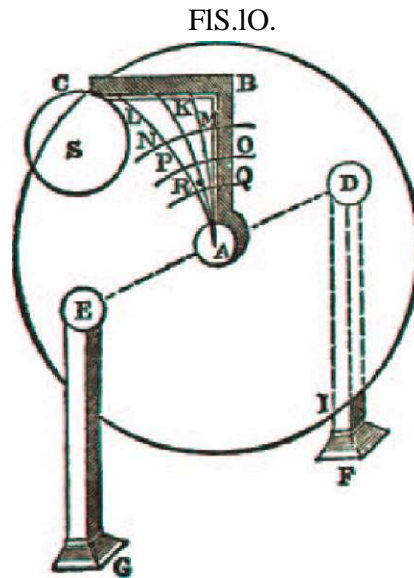

our Hydraulico-Class 2, Machine only in one Gnomon of h e iner, in in Number XV., Artificial Motion and attempts to manner. Let a C be suspended verse, and bound supported by the at the pole D or but the gnomon

say that the C to H and

the greatest force of that tendency is exerted in the line B, and induces it to inclination; which inclination on account of the continuous solidity of the gnomon cannot be at all abated, so that the whole impetus is exerted either at the point A about the movable beam or at the movable poles of the beam D and E; which poles being free in their sockets D and E, abandon themselves to the motion of Nature, and thus do not in any wise hinder a perpetual circular motion. What indeed is self-evident in this, reason confirms, and daily experience in statics manifests. For if a short gnomon stand either on the terrestrial superficies M N, O P, or Q R; it will always fall towards the part C, or N, by the preponderating portion M K C; which is manifested in daily experiments.

Thence it is evident that if the gnomon were entire, the force which it exerts at N would pass into the line B A still hanging over the centre. And this is one argument. The other is from the contrary. For if an equal and similar gnomon were attached towards the part D, then the whole mass hanging on its centre would remain in equilibrium and there would be no motion; consequently the one half being taken away, the other would necessarily move according to the laws and experience of statics. If the shortened gnomon M B C N were bound only to the point M, the rest being left free, it would certainly revolve, and in the same case, the point C would describe almost a semicircular arc till, coming down to a perpendicular position, it would there remain.

Now as the force of the entire gnomon falls in the vertex A, there would be an entire and perpetual revolution around A. Much more would this be the case if on the centre C stood either the small curve A C L A or the larger one A K C, or finally the globe S' alone, hanging from two iron rods A B and B C, or from one arc, A N C. From this, therefore, it may be demonstrated that a perpetual circular motion is possible.

In 1825, the following was contributed to and published in "Mechanics' Magazine." We are unable to give the name of the contributor, but he writes in encouragement of Perpetual Motion. The gist of his article is as follows:

We can now, however, soar above the clouds, explore the depths of the ocean, and skim over its surface. \* \* \* And be it remembered that we owe these and many other advantages to a few persevering individuals who were, in all probability, stigmatized as chimerical visionaries by those who seem to have an unconquerable propensity to condemn everything above the level of their own understanding.

If by perpetual motion nothing more is meant than the putting in motion some of the most durable substances with which we are acquainted, in such a manner as to ensure a continuance of motion as long as those substances will resist the effects of time and friction, I do not despair of seeing it accomplished. \* \* \* [He thinks there is] reasonable ground to hope that the time is not far distant when even this impossibility must yield to persevering ingenuity. In the present state of public opinion with regard to its practicability, it would be looked upon as an empty boast, were I to assert that the discovery is already made.

### **T. H. Pasley**

T. H. Pasley in 1824, contributed an article to "Mechanics' Magazine," asserting the possibility of Perpetual Motion. The following excerpts give the substance of his article:

I feel no hesitation in standing up in support of this grand desideratum, this almost forsaken friend of science, whether the thing be practicable or not.

On the contrary, "Persevere" should be every one's advice; to do so, or discontinue, every one's own pleasure. And why should the impossibility of anything be pronounced unless it be established wherein the limits of possibility consist?

It is puerile in the extreme to be foretelling defeat when so many other objects may be gained by the highly laudable pursuit, perhaps of greater advantage to society at large than the discovery in question. \* \* \* In a word, were the perpetual motion discovered tomorrow, it would be wise of all the governments of the world to offer a very high reward for some species of discovery that would be universally sought after, although it might never be found out. \* \* \* The effects of industry are enlargement of the mind, accumulation of knowledge, and rendering ourselves ignorant of the torments which idleness and dulness always engender. \* \* \* In the next place, there are no solid grounds for the assertion that the discovery of a perpetual motion is an impossibility. In the present state of human knowledge respecting the powers of nature, it is not demonstrable one way or another. \* \* \* The study of what relates to the perpetual motion has this great advantage, that it directs to the discovery of error as well as of truth; whereas, what are they which are called truths of science at present but vacillating human opinions, or erroneous assumptions of what we call natural causes? What are they but such as consist in mere assumption, sanctioned by time, and admitted by existing authorities in science, and of course generally acquiesced in, without previous investigation?

So far, then, from being guided in our decision respecting what is possible by the "unerring laws of nature," by "mathematical demonstration," and by "experimental proofs," we are continually misled by an erroneous faith in the nonentity, attraction.

On such an imperfect knowledge of the causes of phenomena, who should say he knows what can or what cannot be discovered?

### **Article From Pamphleteer**

In the "Pamphleteer," published in London, the following by a correspondent whose name we cannot give was published in March of 1822: "A few words inducing towards the discovery of Perpetual Motion, perhaps the actual discovery thereof:"

London, March, 1822.

What is meant by the term "Perpetual Motion?" Is it supposed that there is an undiscovered substance in the world, that will of itself perpetually move, with as little apparent cause as that

which actuates the needle in becoming motionless in one particular position? Or, is it to be found in the combined reaction of mechanical powers ?

The first idea is stamped with a degree of probability, by the mystery of the needle; yet I imagine the latter is relied on with the greater confidence of mankind, and is the pith of the following few words:

It is well known that the weight of a pendulum will almost regain the level from which it descended, losing a little space at every vibration, until it becomes motionless; if of itself it could exceed or even regain the level, doubtless it would become a perpetual motion.

To find a power that will aid the motion of the pendulum, and in conjunction renew its strength, is what is wanted to create perpetual motion.

What I shall endeavor to explain will at least induce towards the discovery of this power.

The principal parts of the machinery about to be shown are in number three:

A vibrating pendulum.

A revolving pendulum, and A tubular lever.

A vibrating pendulum in motion describes a segment of a circle, and returns on the same segment, and at every vibration its described segment decreases.

A revolving pendulum is composed of two or more pendulums, united at their lighter extremities, there revolving on an axis, the heavier extremities being placed at equal distances in the outer circle: this, I believe, is what is termed a fly-wheel when affixed to hand-mills, etc.

The tubular lever is the chief instigator of the whole, and must contain a weight apportioned to the weights of the two pendulums.

Fix the lever on a cross axis; thus, on an axis within a circle, the circle on an axis at opposite angles, thereby is given to each extremity of the lever a revolving power of motion; attach one extremity of the lever to the outer circle of a revolving pendulum, the other extremity confine within the bar of the vibrating pendulum; thus combined, the effect to be produced when put in motion will be this:

The two pendulums will guide the motion of the lever, which then partakes of the power of a pendulum, giving fresh impulse at every vibration of the pendulum, and every half revolution of the revolving pendulum; for, as each extremity of the lever rises, the weight within falls to the opposite extremity, and gives fresh impulse to the whole: thus (if my idea is correct) will be produced motion perpetual that is to say, perpetual so long as the materials of which it is made will hold together. I have given this short description merely by way of example, as I believe there are several ways of combining these three powers, so as to produce perpetual motion, if my idea on the subject is correct.

The lever may contain mercury or a solid orb of heavy substance; and if the tube be exhausted of air the weight will pass more freely, and certainly increase the power of the lever.

### **J. Welch**

In 1825 the following article was published in "Mechanics' Magazine," having been contributed by J. Welch:

Those who condemn the notion altogether seem to have taken but a very confined view of the subject. What they say about mere matter is right enough; but they seem to forget that there are other active agents in nature which possess wonderful powers, that have nothing to do with either bulk, weight, or form. Such are electricity, magnetic attraction, capillary attraction, and the irregular pressure of the atmosphere. The powers of electricity are great, and, indeed, it seems to be

the *primum mobile* that gives life and motion to the animated part of the creation. Dr. Franklin shows us how to give a circular coated plate, revolving on an axle, sufficient power to roast a chicken, merely by once changing (charging?) it. Could not a plate of this kind be made to turn a small electrical apparatus, so situated as to keep the charge in the plate always at its maximum? The whole might be kept dry by having it enclosed in a glass case.

It has often been attempted to give motion to a wheel by the power of a loadstone, but hitherto without effect; no substance in nature being found to have the power, by interposition, of cutting off its attractive property. Still I think it should be further investigated. Is a small piece of steel in the form of a wedge as strongly attracted at the smaller end as at the thicker? And would not twenty or thirty pieces of steel, of that form, placed round the circumference of a circle, the point of one towards the head of the other, cause a magnet placed in the centre, to revolve in the direction in which their points lie? I think, perhaps not; but still such experiments should be tried.

In capillary attraction we have a power that at once raises fluids above their level. It is this which carries the oil up the wick of a lamp as fast as the flame consumes it. Water and other fluids rise through cotton even quicker than oil; and he who can contrive to collect them as they arrive at the top will discover perpetual motion. Would not water run constantly through a siphon, one which was made of a collection of capillary tubes, and the other in the usual way? or would the water above and below the tubes neutralize and destroy their power?

I now come to the pressure of the atmosphere, a thing easily understood. \* \* \* Make a cast-iron barometrical tube, with a top sufficiently large to contain 2 cwt. of mercury; invert it in a basin large enough to contain

2 or 3 cwt. more, and let a piece of iron of 10 or 12 stones weight float on the mercury in this basin, so as to rise and fall along with it at every change of the weather. We have here both motion and power. The motion, indeed, will sometimes stand still, but then it can easily be regulated, and made a constant quantity in the machine to be attached.

I have no doubt but clocks, etc., may be made to derive their chiming principle from a contrivance of this nature.

**Article From Mechanics' Magazine**

In 1831, the following article was contributed by an unknown correspondent to, and published in "Mechanics' Magazine":

"Yes; we shall conquer ! All those dangers past Will serve to enrich the future story."

The application to the subject, on my part, has been accompanied by continual experimental elucidations of the subjects considered, and comparisons of these with the axioms, theorems, and demonstrations of one of the best authorities, if I may be allowed so to call my favorite author, Emerson, whose *I says* are generally correct.

I disagree with Mr. B., and do trust that even a perpetual motion seeker might deserve encouragement, if it be found that such a character may exist in a person who is not so ignorant of first principles as Mr. B. supposes *all* are who have this bias; especially if it be found that the person's researches have been connected with subjects of a more tangible nature, relating to the improvement of the useful arts, and particularly to some modern inventions of high importance that are not perfectly correct in their construction.

In this article, Mr. B. advises those who are misspending their time in this pursuit, to consider the question in its most simple form, divested of more complicated operations, which simple form is that of a pulley accurately constructed so as to reduce the resistance to motion as much as possible. He says, "it will be found, as long as the weights are equal" there will be no motion produced, but wherever the weights are placed they will remain; and to produce vertical motion in the smallest degree, it will be necessary to add a weight to one of the former to create a preponderancy. This weight he calls the mechanical loss, and an insurmountable bar to perpetual motion, etc. We need not follow Mr. B. to his conclusion, as I think this insurmountable bar can be easily removed; and I shall be able to show that this equilibrium, for such it merely is, can be destroyed without adding to one of the weights, or absolutely taking from the other; though this may virtually be considered to be the case, inasmuch as we can at least produce an effect on the system as if the weight were reduced. Mr. B. says, under this arrangement, "wherever the weights are placed they will remain, unless an addition is made to one of them." We will therefore suppose the following diagram to represent the arrangement on a small scale, delicately constructed.

A B are the two weights connected to each other by the string passing over the pulley, and being nicely equalized in their equilibrium on the principle of the lever. But take a flat piece of wood, such as a ruler, and place it obliquely in a way so as not to interfere with the weight to weight A m, C d, consequence? then descend, and rather say, the weight B, having takes place. Now, so far as to say simple motion takes communicated to machine itself, such. Then, why

A B are the two weights connected to each other by the string passing over the pulley, and being nicely equalized in their equilibrium on the principle of the lever. But take a flat piece of wood, such as a ruler, and place it obliquely in a way so as not to interfere with the weight to weight A m, C d, consequence? then descend, and rather say, the weight B, having takes place. Now, so far as to say simple motion takes communicated to machine itself, such. Then, why

Some would say, why, the weight A would cause the weight B to ascend. But I should rather say, the weight B, having takes place. Now, so far as to say simple motion takes communicated to machine itself, such. Then, why

the reaction of the plane when acted on by the destroyed the equilibrium of the forces, motion if we attribute this motion to the reaction of the plane on the weight, though we will not go motion is generated, yet if we say, by this arrangement the equilibrium is destroyed and place, the least we can admit is, that motion is the system, and that by the agency of part of the the apparatus employed being considered as so much objection to the term self-moving machine in limited sense? But I will not dispute about words, which are but the images of things, and images may be strangely distorted by the medium through which they are received of which distorting mediums, there is none equal to that of prejudice in favor of abstract notions which notions perhaps, if rigidly examined, would be found to have no foundation in facts or in common sense.

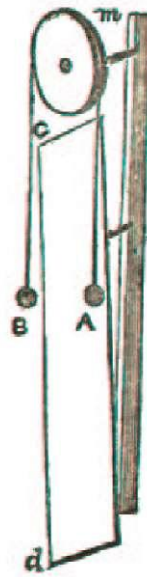

other by the string equalized in their equilibrium on of wood, such as to interfere with the weight to weight A m, C d, consequence? then descend, and rather say, the weight B, having takes place. Now, so far as to say simple motion takes communicated to machine itself, such. Then, why

Another demonstrator of the impossibility of perpetual motion, is Mr. Mackinnon (see "Mechanical Magazine," Vol. 1, Page 363). As no doubt the different attempts to produce, or communicate, continued and perpetual motion, at least, such as are often brought forward by persons unacquainted with the science of mechanics, are generally to those who are acquainted with that science, if not absolutely ridiculous, yet of a nature to excite a smile at their futility: still there are a few (perhaps a very few) who entertain an opinion that such a thing is not impracticable, and who have, from practical experience as well as study,

acquired a tolerable insight into the laws of nature (so far as relate to this subject) ; who in their turn cannot help smiling at the weak reasoning of some other would-be philosophers, who gravely give their dictum in the case. In this class I include Mr. Mackinnon, who very gravely goes to work to prove, etc., and flatters himself he shall, if rightly understood, help to prevent much future waste of time on the subject. He then goes on to give us his definition of inertia, by which he informs us that a body in a state of rest will remain so until it is moved (wonderful!) that it cannot move itself that it has not that power and that no mechanical contrivance can give it that power. (How profound!)

